

gigambarelli.it

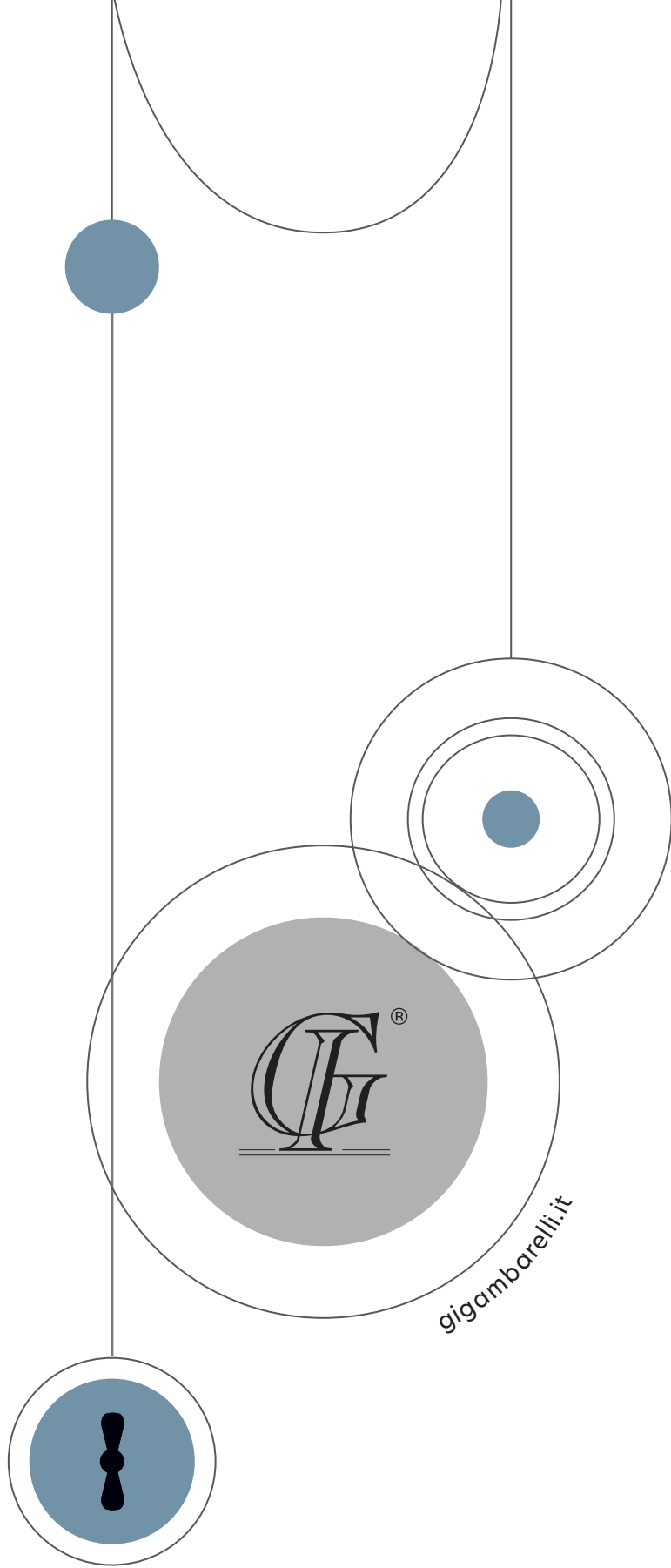

unforgettable

2023|2024 COLLECTIONS



gigambarelli.it



Yesterday, today, tomorrow.
Thirty years of history and an unforgettable product.

unforgettable

2023 | 2024 COLLECTIONS



2023 | 2024 COLLECTIONS

about us	4
white italy	10
ardesia	22
atlantis	32
simplex	42
cables and accessories	50
fusion	66
arreda	78
lamp 30's	92
accessories kit 30's	120
gi-loft	128
spare parts	158
sample panels	164

GI Gambarelli was founded in 1992 and it was the result of love, passion for beauty, and constant search for new shapes, materials, colours and finishes. From the very beginning, **Ilario Gambarelli** saw the electrical system as a real piece of furniture and wanted to transform it into something that goes beyond its primary functionality.

Less is more

Ludwig Mies Van Der Rohe
Architect





Porcelain

Since ancient time, porcelain has been seen as **a prestigious raw material** thanks to its intrinsic qualities. The visual elegance and the union between **refinement and solidity** are some of the features that make it unique and inimitable.

Porcelain has an unparalleled and eternal **shine**.

In fact, it is not subject to the aging process and gives refinement to any environment it hosts.

It is a unique decorative material, which characterizes all our collections and adds a touch of unrivaled class and style.



The essence of quality

There are many aspects that contribute to define our **competitive advantage** which is recognized both in Italy and abroad, where we own a large customer portfolio. Some of them are: **high quality** raw materials, production process characterized by **triple cooking**, guaranteeing maximum quality; **adaptation** of porcelain to the trends and needs of today's market.

Particular attention should be paid to the **Italian design**, characterized by meticulous care to details and the qualitative and functional properties of the products, considered an authentic **excellence**.



White porcelain certification.

We can ensure the quality and authenticity of the white of porcelain, achieved through the use of materials free of impurities and a constant monitoring of each stage of the production process. The result of all these checks is a polished white. A protective layer of transparent vitrifying agent reveals the essence of porcelain and mixture, and the purity of ingredients.



Switches and Sockets in Pure Porcelain

I want something more... precious porcelains, sensations frozen in time



white italy



Luxury Vintage

We have everything you need to recreate visible electrical systems. Our white porcelain elements are the result of a **triple cooking** which gives them a singular quality. They are ideal for the renovation of rooms where it is not possible to install traditional systems.



An elegant and flexible line



A vintage style that will amaze you. Its components are incredibly versatile and, although they were **mainly designed to be inserted in conservative renovation systems**, they can also be used in modern projects, creating pleasant contrasts with the colours of cables and accessories.

→ preview









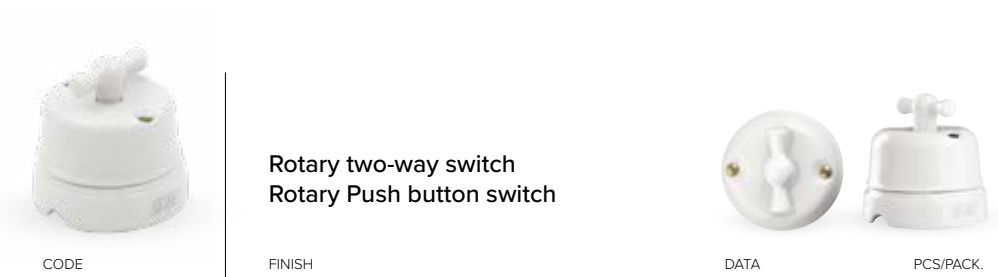

 CODE	TYPE	 DATA	 PCS/PACK.
00100	Rotary one-way Switch	Ø 60 h 67 mm 1P 10AX 250V~ IP20 ☑	
00110	Rotary two-way Switch	Ø 60 h 67 mm 1P 2 vie 10AX 250V~ IP20 ☑	1
00120	Rotary Push Button Switch	Ø 60 h 67 mm 1P 10A 250V~ IP20 ☑	

 CODE	FINISH	 DATA	 PCS/PACK.
00300	 Classic White		
00601	 Classic Gold		
00602	 Classic Chrome	Ø 60 h 67 mm 1P 10AX 250V~ IP20 ☑	1
00603	 Classic Bronze		
00604	 Classic Copper		



CODE	FINISH	DATA	PCS/PACK.
00310	 Classic White Two-way Switch	Ø 60 h 67 mm 1P 2 vie 10AX 250V~ IP20 CE	1
00611	 Classic Gold Two-way Switch		
00612	 Classic Chrome Two-way Switch		
00613	 Classic Bronze Two-way Switch		
00614	 Classic Copper Two-way Switch		

00320	 Classic White Push Button Switch	Ø 60 h 67 mm 1P 10A 250V~ IP20 CE	1
00621	 Classic Gold Push Button Switch		
00622	 Classic Chrome Push Button Switch		
00623	 Classic Bronze Push Button Switch		
00624	 Classic Copper Push Button Switch		

	Switch with Key		
CODE	FINISH	DATA	PCS/PACK.
00109	Chrome	$\varnothing 60$ h 53 mm 1P 1A 12V~ IP20 CE	1
	Push Button		
CODE	FINISH	DATA	PCS/PACK.
00130	Polished Gold	$\varnothing 60$ h 53 mm 1P 2A 12V~ IP20 CE	1
00134	Matt Chrome		
	Socket-outlet		
CODE	TYPE	DATA	PCS/PACK.
00200	Italian Standard	$\varnothing 60$ h 45 mm P11/P17 10-16A 250V~ IP20 CE	1
	UNEL socket-outlet		
CODE	TYPE	DATA	PCS/PACK.
00210	European Standard	$\varnothing 65$ h 51 mm P30/P11 16A 250V~ IP20 CE	1

	Schuko Socket-outlet					
CODE	TYPE	DATA PCS/PACK.				
00211	German Standard	<table border="1"> <tbody> <tr> <td>Ø 65 h 51 mm</td> <td rowspan="3">1</td> </tr> <tr> <td>16A 250V~</td> </tr> <tr> <td>IP20 CE</td> </tr> </tbody> </table>	Ø 65 h 51 mm	1	16A 250V~	IP20 CE
Ø 65 h 51 mm	1					
16A 250V~						
IP20 CE						
	French Socket-outlet					
CODE	TYPE	DATA PCS/PACK.				
00250	French Standard	<table border="1"> <tbody> <tr> <td>Ø 65 h 51 mm</td> <td rowspan="3">1</td> </tr> <tr> <td>16A 250V~</td> </tr> <tr> <td>IP20 CE</td> </tr> </tbody> </table>	Ø 65 h 51 mm	1	16A 250V~	IP20 CE
Ø 65 h 51 mm	1					
16A 250V~						
IP20 CE						
	English Socket-outlet					
CODE	TYPE	DATA PCS/PACK.				
00253	British Standard	<table border="1"> <tbody> <tr> <td>Ø 65 h 51 mm</td> <td rowspan="3">1</td> </tr> <tr> <td>13A 250V~</td> </tr> <tr> <td>IP20 CE</td> </tr> </tbody> </table>	Ø 65 h 51 mm	1	13A 250V~	IP20 CE
Ø 65 h 51 mm	1					
13A 250V~						
IP20 CE						
	Telephone Socket					
CODE	TYPE	DATA PCS/PACK.				
00220	RJ 11 6P	<table border="1"> <tbody> <tr> <td>Ø 60 h 45 mm</td> <td rowspan="2">1</td> </tr> <tr> <td>IP20 CE</td> </tr> </tbody> </table>	Ø 60 h 45 mm	1	IP20 CE	
Ø 60 h 45 mm	1					
IP20 CE						

 CODE	Data Socket TYPE	 DATA	PCS/PACK.
00230	RJ45 unshielded	$\varnothing 60$ h 45 mm C.5E UTP T568A - B C.5E IP20 CE	1
 CODE	Coaxial TV Connector - Female TYPE	 DATA	PCS/PACK.
00240	Female TV	$\varnothing 60$ h 50 mm $\varnothing 9.5$ femmina IP20 CE	1
 CODE	Coaxial TV Connector - Male TYPE	 DATA	PCS/PACK.
00241	Male TV	$\varnothing 60$ h 50 mm $\varnothing 9.5$ maschio IP20 CE	1
 CODE	Sat Socket TYPE	 DATA	PCS/PACK.
00242	SAT connector	$\varnothing 60$ h 55 mm IP20 CE	1

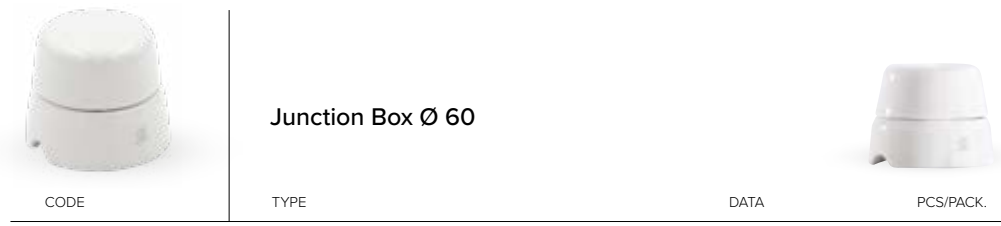

01500

Ø 60

Ø 60 | h 51 mm
IP20

1



01510

Ø 80

Ø 80 | h 57 mm
IP20

1

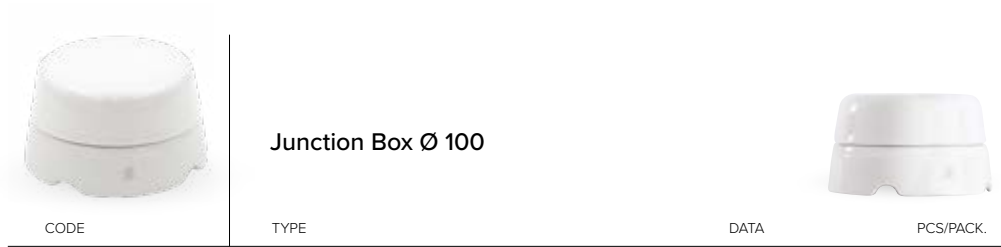





01520





Ø 100

Ø 100 | h 59 mm
IP20 | CE

1



 CODE	Ceiling Cup - Smooth TYPE	 DATA	PCS/PACK.
01600	 Ceiling Cup Ø 80	Ø 80 h 35 mm	2
01610	 Ceiling Cup Ø 100	Ø 100 h 35 mm	

 CODE	Ceiling Cup - Decorated TYPE	 DATA	PCS/PACK.
01601	 Ceiling Cup Ø 80	Ø 80 h 35 mm	2
01611	 Ceiling Cup Ø 100	Ø 100 h 35 mm	





Architecture is an invention

Oscar Niemeyer

Architect

ardesia

Rough porcelain switches and sockets

The rough slate-coloured porcelain is a **surprising and charming combination**, and gives rise to an ethereal design that recalls vintage and is perfectly suited to **industrial and modern styles**.

These authentic furnishings become protagonists of the environment, providing it with a marked **personality**.





The electrical system becomes an art installation integrated into the surrounding environment









The rough porcelain finish, with a fascinating matt charcoal grey colour, makes the Ardesia a unique collection. The combination of the collection and visible cables creates extremely **versatile** locations, in line with both a sober and austere style and modern, industrial and vintage contexts.









→ preview

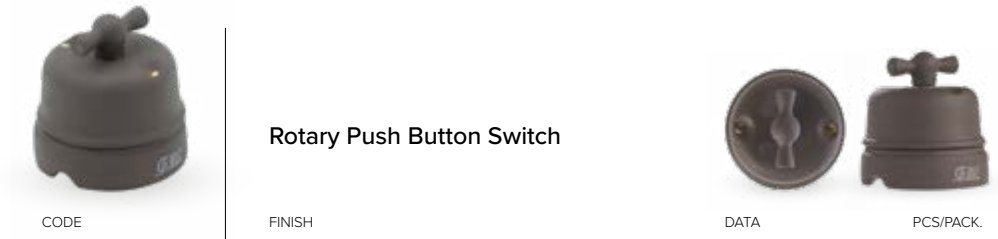

 CODE	TYPE Rotary one-way/two-way Push Button Switch	 DATA	 PCS/PACK.
AX00110	Rotary one-way/two-way Moon Charcoal Grey	Ø 60 h 67 mm 1P 2 vie 10AX 250V~ 10AX IP20 CE	1
AX00120	Rotary Push button switch Moon Charcoal Grey	Ø 60 h 67 mm 1P 10A 250V~ IP20 CE	1

 CODE	FINISH Rotary two-way Switch	 DATA	 PCS/PACK.
AX00310	 Classic Charcoal Grey		
AX00611	 Classic Gold		
AX00612	 Classic Chrome	Ø 60 h 67 mm 1P 2 vie 10AX 250V~ IP20 CE	1
AX00613	 Classic Bronze		
AX00614	 Classic Copper		



CODE	FINISH	DATA	PCS/PACK.
AX00320	 Classic Charcoal Grey	Ø 60 h 67 mm 1P 10A 250V~ IP20 CE	1
AX00621	 Classic Gold		
AX00622	 Classic Chrome		
AX00623	 Classic Bronze		
AX00624	 Classic Copper		

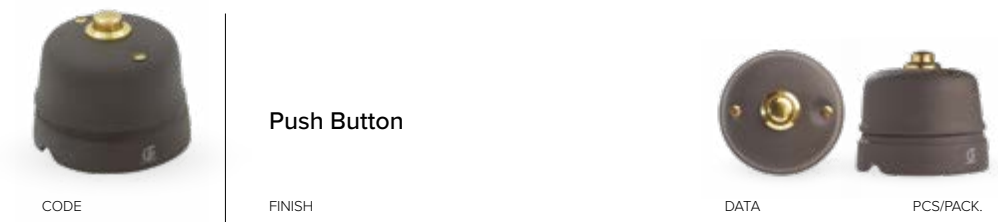

CODE	FINISH	DATA	PCS/PACK.
AX00130	 Polished Gold	Ø 60 h 53 mm 1P 2A 12V~ IP20 CE	1
AX00134	 Matt Chrome		

 CODE	Socket-outlet TYPE	 DATA	PCS/PACK.
AX00200	Italian Standard	\varnothing 60 h 45 mm P11/P17 10-16A 250V~ IP20 CE	1
 CODE	UNEL Socket-outlet TYPE	 DATA	PCS/PACK.
AX00210	European Standard	\varnothing 65 h 51 mm P30/P11 16A 250V~ IP20 CE	1
 CODE	Schuko Socket-outlet TYPE	 DATA	PCS/PACK.
AX00211	German Standard	\varnothing 65 h 51 mm 16A 250V~ IP20 CE	1
 CODE	French Socket-outlet TYPE	 DATA	PCS/PACK.
AX00250	French Standard	\varnothing 65 h 51 mm 16A 250V~ IP20 CE	1

CODE	TYPE	DATA	PCS/PACK.
	Telephone Socket		
AX00220	RJ 11 6P	Ø 60 h 45 mm 6P/4C RJ 11 IP20 CE	1
	Data Socket		
AX00230	RJ45 Unshielded	Ø 65 h 45 mm C.5E UTP T568A – B IP20 CE	1
	Coaxial TV Connector - Female		
AX00240	Female TV	Ø 60 h 50 mm Ø 9.5 femmina IP20 CE	1
	Coaxial TV Connector - Male		
AX00241	Male TV	Ø 60 h 50 mm Ø 9.5 maschio IP20 CE	1





Sat Socket



CODE

TYPE

DATA

PCS/PACK.

AX00242

SAT connector

Ø 60 | h 55 mm

IP20 | CE

1



Junction Box



CODE

TYPE

DATA

PCS/PACK.

AX01500

Ø 60

Ø 60 | h 51 mm

IP20 | CE

1



Junction Box



CODE

TYPE

DATA

PCS/PACK.

AX01510

Ø 80

Ø 80 | h 57 mm

IP20 | CE

1

Downtown Design Mood

Modern and urban, it is ideal for the frenzy of 'downtowns', lofts, shared spaces, retail

Industrial Chic

The solution proposed concerns a pleasant **contrast between ancient and modern**. The ancient is represented by porcelain electrical components and the modern is attributable to the polycarbonate tube with the visible cable fixed by metal clips with antique copper, chrome and micro-peened gold finishes.

You can choose from **different colours and type of materials** to obtain multiple solutions that adapt to the various designs.





atlantis



Double safety thanks to the polycarbonate tube

Our installations are **ideal for environments such as shops**, restaurants and bars that can host a large number of people. To ensure maximum safety and a **modern look** at the same time, cables can be protected by a **transparent polycarbonate tube**. In this way, the environment will have a contemporary industrial look and the system will not run any risk of damage resulting from accidental cuts or tears.

VDE certification

The collection has been conceived, studied and tested in compliance with the VDE technical standards, i.e. the regulations that deal with the safety and suitability of appliances compared to German Standard.

→ preview







CODE

Rotary one-way/two-way Switch

FINISH









DATA















PCS/PACK.

CODE	FINISH	DATA	PCS/PACK.
00101.10 00102.10	  	Ø 60 h 70 mm 1P 2 vie 10AX 250V~ IP20 CE	1
00101.11 00102.11			
00101.12 00102.12			
00101.13 00102.13			
00101.14 00102.14			
00121.10 00122.10	  	Ø 60 h 70 mm 1P 2 vie 10AX 250V~ IP20 CE	1
00121.11 00122.11			
00121.12 00122.12			
00121.13 00122.13			
00121.14 00122.14			





 Base with 1 hole for ending connection |
  Base with 2 holes for through going connection





	Rotary one-way/two-way Push Button Switch		
CODE	FINISH	DATA	PCS/PACK.
  00101.00 00102.00	 Rotary one-way/two-way Moon Porcelain	Ø 60 h 61 mm 1P 2A 12V~ IP20 CE	1
00121.00 00122.00	 Rotary Push Button Switch Moon Porcelain		





	Push Button		
CODE	FINISH	DATA	PCS/PACK.
  00130.01 00130.02	 Polished Gold Moon	Ø 60 h 61 mm 1P 2A 12V~ IP20 CE	1
00134.01 00134.02	 Matt Chrome Moon		

	Socket-outlet		
CODE	TYPE	DATA	PCS/PACK.
  00200.01 00200.02	Italian Standard	Ø 60 h 50 mm P11/P17 10-16A 250V~ IP20 CE	1

	UNEL Socket-outlet		
CODE	TYPE	DATA	PCS/PACK.
 		\varnothing 70 h 55 mm	1
00258.01 00258.02	European Standard	P30/P11 16A 250V~	
		IP20 CE	

	Schuko Socket-outlet		
CODE	TYPE	DATA	PCS/PACK.
 		\varnothing 70 h 55 mm	1
00255 00257	German Standard	16A 250V~	
		IP20 CE	

	French Socket-outlet		
CODE	TYPE	DATA	PCS/PACK.
 		\varnothing 70 h 55 mm	1
00254 00256	French Standard	16A 250V~	
		IP20 CE	

	English Socket-outlet		
CODE	TYPE	DATA	PCS/PACK.
 		\varnothing 70 h 55 mm	1
00253.01 00253.02	British Standard	13A 250V~	
		IP20 CE	

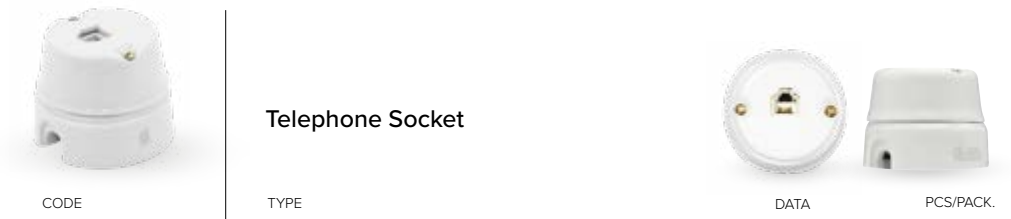

CODE

TYPE

DATA

PCS/PACK.



00220.01 | 00220.02

RJ 11 6P

Ø 60 | h 50 mm

6P/4C | RJ 11

IP20 | CE

1

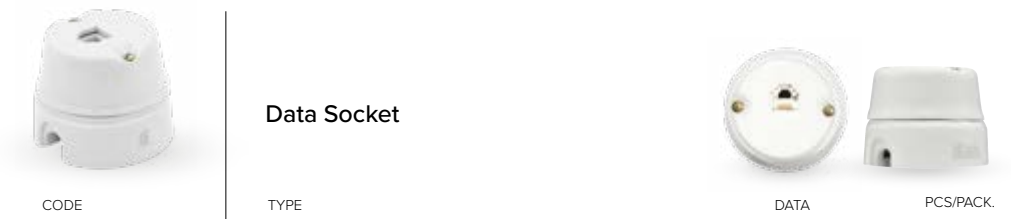

CODE

TYPE

DATA

PCS/PACK.



00230.01 | 00230.02

RJ45 Unshielded

Ø 60 | h 50 mm

C.5E | UTP | T568A - B

IP20 | CE

1

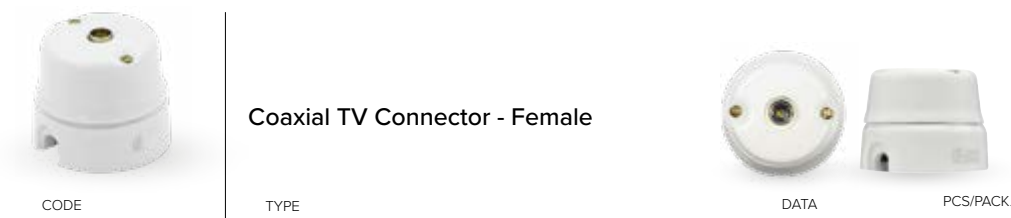

CODE

TYPE

DATA

PCS/PACK.



00240.01 | 00240.02

Female TV

Ø 60 | h 50 mm

Ø 9.5 femmina

IP20 | CE

1

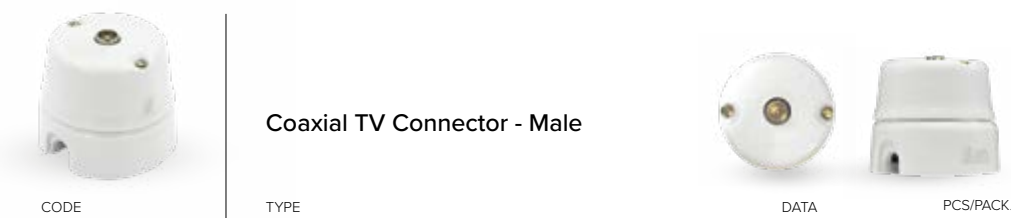

CODE

TYPE

DATA

PCS/PACK.



00241.01 | 00241.02





Male TV





Ø 60 | h 50 mm



Ø 9.5 maschio

IP20 | CE

1

	Atlantis Sat Socket		
CODE	TYPE	DATA	PCS/PACK.
  00242.01 00242.02 Sat		Ø 60 h 55 mm IP20 ☼	1

	Ceiling Cup - Smooth		
CODE	TYPE	DATA	PCS/PACK.
  01600.01 01600.02 Ceiling Cup Ø 80		Ø 80 h 41 mm	2

	Junction Box Ø 80		
CODE	TYPE	DATA	PCS/PACK.
01510.04	Ø 80	Ø 80 h 60 mm IP20 ☼	1

	Closing Cup for Switches and Socket "Atlantis"	
CODE	FINISH	PCS/PACK.
36506	Porcelain effect rubber	1





Transparent Polycarbonate Tube

CODE	TYPE	DATA	PCS/PACK.
36502.01	Tube 1 m	Ø 16 1 m	1
36502	Tube 2 m	Ø 16 2 m	





Tube Connection

CODE	FINISH	DATA	PCS/PACK.
36503.01	 Gold	Ø 16 30	1
36503.02	 Chrome		
36503.03	 Copper		





Curve 90°

CODE	FINISH	DATA	PCS/PACK.
36504.01	 Gold	Ø 16 35 h 35 mm	1
36504.02	 Chrome		
36504.03	 Copper		



Clip for Tube / Wall Support

CODE	FINISH	DATA	PCS/PACK.
36505.01	 Gold	Ø 16 41 h 21 mm	1
36505.02	 Chrome		
36505.03	 Copper		

simplex



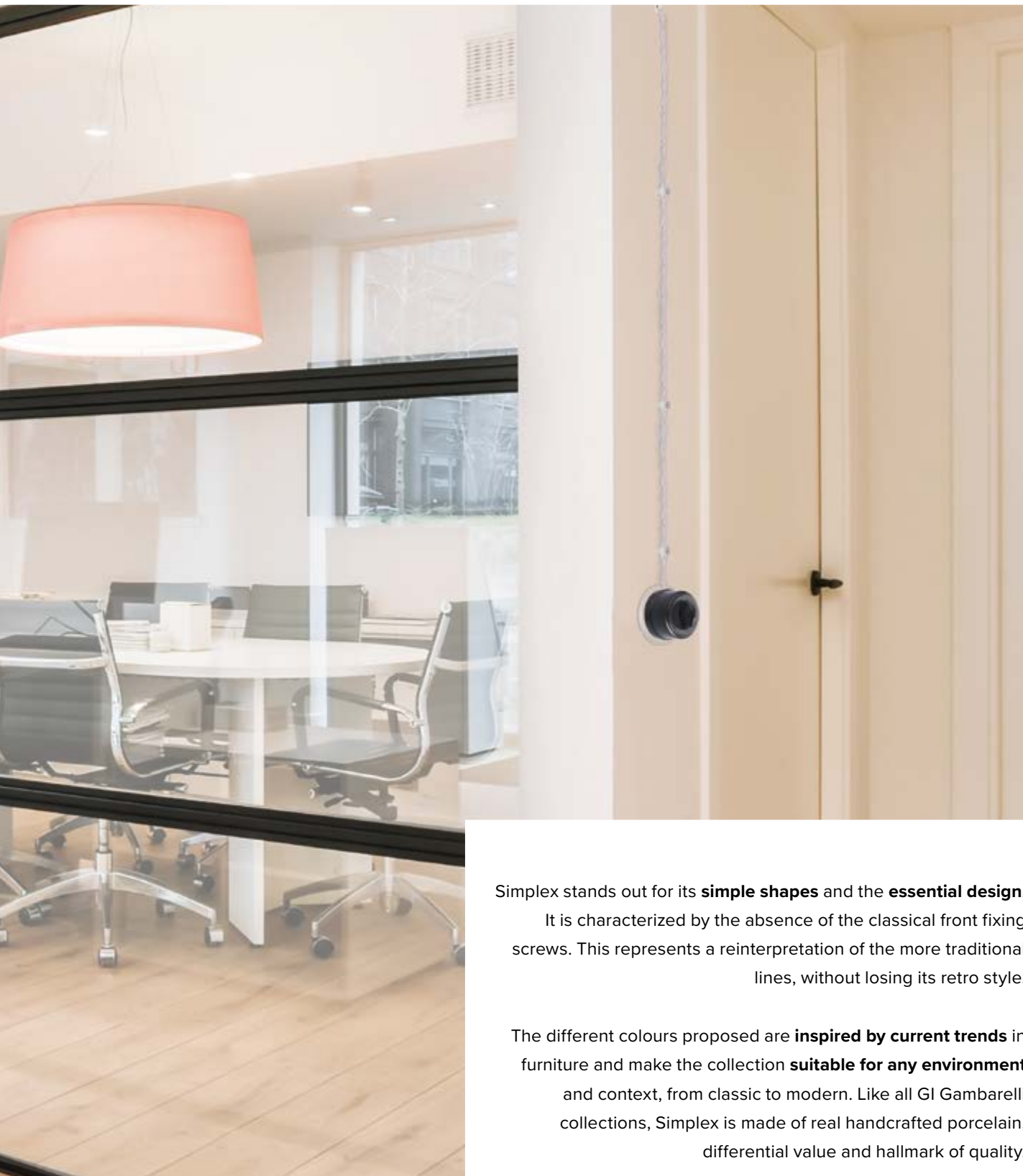

Simplex stands out for its **simple shapes** and the **essential design**.

It is characterized by the absence of the classical front fixing screws. This represents a reinterpretation of the more traditional lines, without losing its retro style.

The different colours proposed are **inspired by current trends** in furniture and make the collection **suitable for any environment** and context, from classic to modern. Like all GI Gambarelli collections, Simplex is made of real handcrafted porcelain, differential value and hallmark of quality.

Lively and eccentric

The Simplex collection goes well with **modern and conceptual environments**. The installation integrates into the space in a creative way, influencing its surfaces.

This allows us high **flexibility** in the choice of colours, cables and installation methods, providing **endless combination possibilities**.



→ preview







Rotary one-way/two-way Switch

CODE	FINISH	DATA	PCS/PACK.
SX110.B	Polished White	Ø 70 h 65 mm 1P 2vie 10AX 250V~ IP20 ☐	1
SX110.N	Matt Black		
SX110.V	Polished Green		
SX110.T	Polished Light Grey		



Rotary Push Button Switch

CODE	FINISH	DATA	PCS/PACK.
SX120.B	Polished White	Ø 70 h 65 mm 1P 10AX 250V~ IP20 ☐	1
SX120.N	Matt Black		
SX120.V	Polished Green		
SX120.T	Polished Light Grey		



Socket-Outlet Italian Standard

CODE	TYPE	DATA	PCS/PACK.
SX200.B	Polished White	Ø 70 h 45 mm P11/P17 10-16A 250V~ IP20 ☐	1
SX200.N	Matt Black		
SX200.V	Polished Green		
SX200.T	Polished Light Grey		

The handcrafted product of porcelain for the realization of coloured products is subject to colour and shade variations.







UNEL socket-outlet European Standard

CODE	TYPE	DATA	PCS/PACK.
SX210.B	 Polished White	Ø 70 h 45 mm P30/P11 16A 250V~ IP20 CE	1
SX210.N	 Matt Black		
SX210.V	 Polished Green		
SX210.T	 Polished Light Grey		







Telephone/Data Socket

CODE	TYPE	DATA	PCS/PACK.
SX220.B	 Polished White	Ø 70 h 45 mm C.5E UTP T568A-B IP20 CE	1
SX220.N	 Matt Black		
SX220.V	 Polished Green		
SX220.T	 Polished Light Grey		



Coaxial TV connector/Sat socket

CODE	TYPE	DATA	PCS/PACK.
SX240.B	 Polished White	Ø 70 h 45 mm TV-M TV-F SAT IP20 CE	1
SX240.N	 Matt Black		
SX240.V	 Polished Green		
SX240.T	 Polished Light Grey		

		Junction box Ø 75			
CODE	TYPE	DATA	PCS/PACK.		
SX151.B	 Polished White	Ø 75 h 50 mm IP20 €€	1		
SX151.N	 Matt Black				
SX151.V	 Polished Green				
SX151.T	 Polished Light Grey				

		Insulator + Screws and Dowels			
CODE	FINISH	DATA	PCS/PACK.		
SX01200.B	 Polished White	Ø 20 h 25 mm €€	25 pz.		
SX01200.N	 Matt Black				
SX01200.V	 Polished Green				
SX01200.T	 Polished Light Grey				

The handcrafted product of porcelain for the realization of coloured products is subject to colour and shade variations.





Architecture is the
masterly volumes
grouped under the light

Le Corbusier
Architect



cables and accessories

Aesthetics and quality,
always appreciated
by our customers

The qualities that are increasingly appreciated by industrial professionals are: **shine, refinement and naturalness of silk**. These professionals, such as architects, designers, installers, artisans and luxury retailers, believe that products are authentic advantage of the offer and also give great importance to **constant availability**, a fundamental factor not to underestimate nowadays.

Co-stars of our design. A benchmark for industry professionals

Our cables are an integral part of our installation. They are **available in silk, cotton and jute** and boast a **wide range of colours and sections**. **The aesthetic of telephone cables** is the same as that of electrical cables because we want them to be anonymous in the eyes of the user. From a functional perspective, they are used in visible electrical systems, in the realization (or restoration) of lighting fixtures, and in many other contexts.



→ preview





Silk Twisted Cable
White



FIMKO

Code	Section	mt.
10001	2x0.5	100
10002	2x0.75	100
10003	2x1	100
10004	2x1.5	100
10005	2x2.5	100
10006	3x0.5	100
10007	3x0.75	100
10008	3x1	100
10009	3x1	50
10010	3x1.5	100
10011	3x1.5	50
10012	3x2.5	100
10013	3x2.5	50
10014	4x1.5	100
10015	4x1.5	50
34007	3x0.75	10
34008	3x1	10
34010	3x1.5	10
10007.B3	3x0.75	3

Silk Twisted Cable
Ivory



FIMKO

Code	Section	mt.
10101	2x0.5	100
10102	2x0.75	100
10103	2x1	100
10104	2x1.5	100
10105	2x2.5	100
10106	3x0.5	100
10107	3x0.75	100
10108	3x1	100
10109	3x1	50
10110	3x1.5	100
10111	3x1.5	50
10112	3x2.5	100
10113	3x2.5	50
10114	4x1.5	100
10115	4x1.5	50
34107	3x0.75	10
34108	3x1	10
34110	3x1.5	10
10107.B3	3x0.75	3

Silk Twisted Cable
Grey



FIMKO

Code	Section	mt.
10201	2x0.5	100
10202	2x0.75	100
10203	2x1	100
10204	2x1.5	100
10205	2x2.5	100
10206	3x0.5	100
10207	3x0.75	100
10208	3x1	100
10209	3x1	50
10210	3x1.5	100
10211	3x1.5	50
10212	3x2.5	100
10213	3x2.5	50
10214	4x1.5	100
10215	4x1.5	50
34207	3x0.75	10
34208	3x1	10
34210	3x1.5	10
10207.B3	3x0.75	3

Silk Twisted Cable
Brown



FIMKO

Code	Section	mt.
10301	2x0.5	100
10302	2x0.75	100
10303	2x1	100
10304	2x1.5	100
10305	2x2.5	100
10306	3x0.5	100
10307	3x0.75	100
10308	3x1	100
10309	3x1	50
10310	3x1.5	100
10311	3x1.5	50
10312	3x2.5	100
10313	3x2.5	50
10314	4x1.5	100
10315	4x1.5	50
34307	3x0.75	10
34308	3x1	10
34310	3x1.5	10
10307.B3	3x0.75	3

Silk Twisted Cable Black



FIMKO   

Code	Section	mt.
10401	2x0.5	100
10402	2x0.75	100
10403	2x1	100
10404	2x1.5	100
10405	2x2.5	100
10406	3x0.5	100
10407	3x0.75	100
10408	3x1	100
10409	3x1	50
10410	3x1.5	100
10411	3x1.5	50
10412	3x2.5	100
10413	3x2.5	50
10414	4x1.5	100
10415	4x1.5	50
34407	3x0.75	10
34408	3x1	10
34410	3x1.5	10
10407.B3	3x0.75	3

Silk Twisted Cable Gold



FIMKO   

Code	Section	mt.
10501	2x0.5	100
10502	2x0.75	100
10503	2x1	100
10504	2x1.5	100
10505	2x2.5	100
10506	3x0.5	100
10507	3x0.75	100
10508	3x1	100
10509	3x1	50
10510	3x1.5	100
10511	3x1.5	50
10512	3x2.5	100
10513	3x2.5	50
10514	4x1.5	100
10515	4x1.5	50
34507	3x0.75	10
34508	3x1	10
34510	3x1.5	10
10507.B3	3x0.75	3

Silk Twisted Cable Bronze



FIMKO   

Code	Section	mt.
10601	2x0.5	100
10602	2x0.75	100
10603	2x1	100
10604	2x1.5	100
10605	2x2.5	100
10606	3x0.5	100
10607	3x0.75	100
10608	3x1	100
10609	3x1	50
10610	3x1.5	100
10611	3x1.5	50
10612	3x2.5	100
10613	3x2.5	50
10614	4x1.5	100
10615	4x1.5	50
34607	3x0.75	10
34608	3x1	10
34610	3x1.5	10
10607.B3	3x0.75	3

Cotton Twisted Cable White



FIMKO   

Code	Section	mt.
18001	2x0.5	100
18002	2x0.75	100
18003	2x1	100
18004	2x1.5	100
18005	2x2.5	100
18006	3x0.5	100
18007	3x0.75	100
18008	3x1	100
18009	3x1	50
18010	3x1.5	100
18011	3x1.5	50
18012	3x2.5	100
18013	3x2.5	50
18014	4x1.5	100
18015	4x1.5	50

Silk Twisted Cable
Autunno



FIMKO   CE

Code	Section	mt.
12018	3x0.75	50
12009	3x1	50
12011	3x1.5	50
35007	3x0.75	10
35008	3x1	10
35010	3x1.5	10
12018.B3	3x0.75	3

Silk Twisted Cable
Tre Ori



FIMKO   CE

Code	Section	mt.
12118	3x0.75	50
12109	3x1	50
12111	3x1.5	50
35107	3x0.75	10
35108	3x1	10
35110	3x1.5	10
12118.B3	3x0.75	3

Silk Twisted Cable
Dalia



FIMKO   CE

Code	Section	mt.
12218	3x0.75	50
12209	3x1	50
12211	3x1.5	50
35207	3x0.75	10
35208	3x1	10
35210	3x1.5	10
12218.B3	3x0.75	3

Silk Twisted Cable
Catena



FIMKO   CE

Code	Section	mt.
12318	3x0.75	50
12309	3x1	50
12311	3x1.5	50
35307	3x0.75	10
35308	3x1	10
35310	3x1.5	10
12318.B3	3x0.75	3



Silk Twisted Cable Brazil



FIMKO   CE

Code	Section	mt.
12418	3x0.75	50
12409	3x1	50
12411	3x1.5	50
35407	3x0.75	10
35408	3x1	10
35410	3x1.5	10
12418.B3	3x0.75	3

Silk Twisted Cable Blue



FIMKO   CE

Code	Section	mt.
10718	3x0.75	50
10709	3x1	50
10711	3x1.5	50
34707	3x0.75	10
34708	3x1	10
34710	3x1.5	10
10718.B3	3x0.75	3

Silk Twisted Cable Red



FIMKO   CE

Code	Section	mt.
10818	3x0.75	50
10809	3x1	50
10811	3x1.5	50
34807	3x0.75	10
34808	3x1	10
34810	3x1.5	10
10818.B3	3x0.75	3

Silk Twisted Cable Dark Grey



FIMKO   CE

Code	Section	mt.
10918	3x0.75	50
10909	3x1	50
10911	3x1.5	50
34907	3x0.75	10
34908	3x1	10
34910	3x1.5	10
10918.B3	3x0.75	3

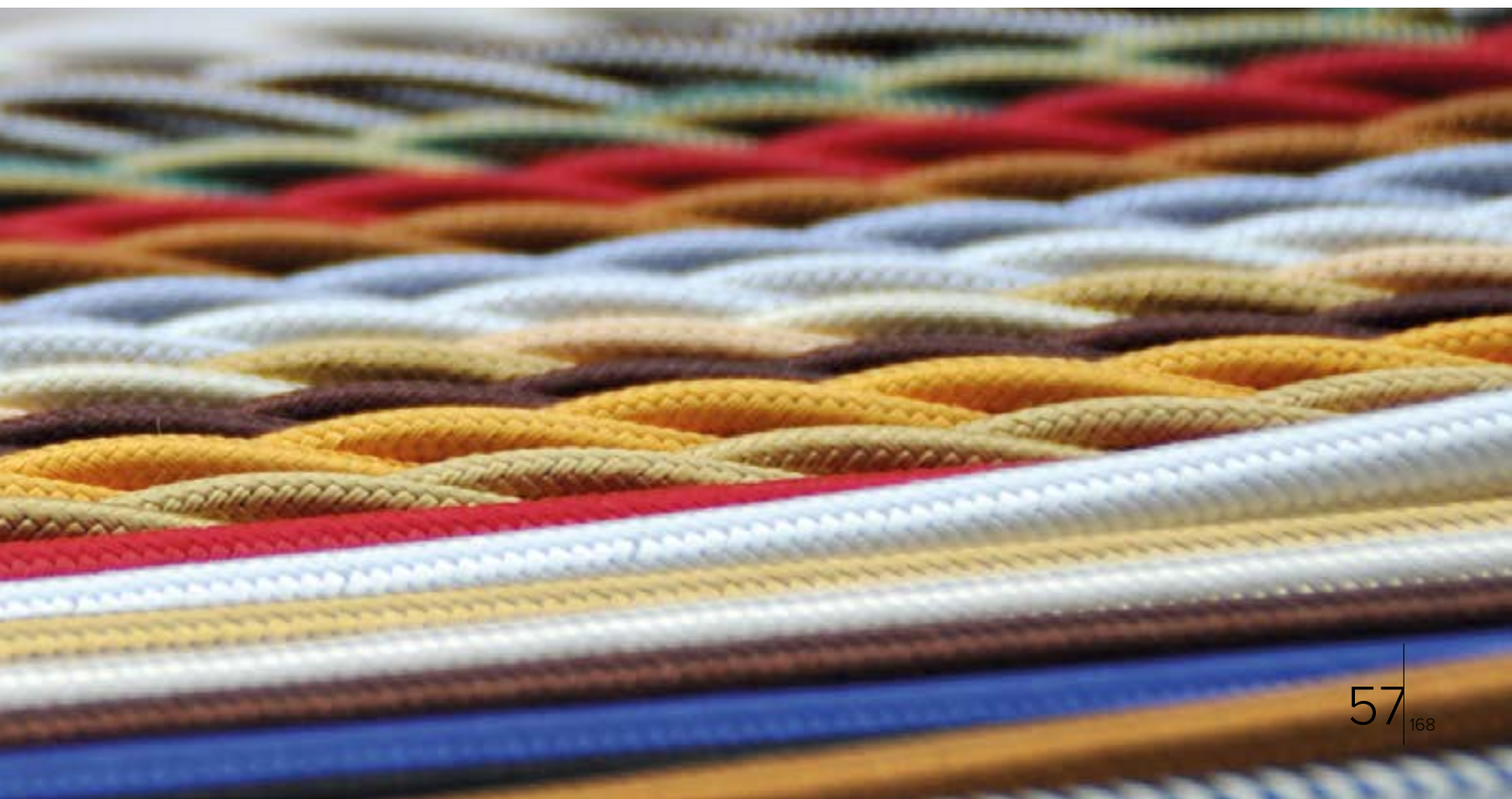

TV Twisted Cable



Silk Twisted Cable

	Code	Colour	m
	20001	White	50
	20101	Ivory	50
	20201	Grey	50
	20301	Brown	50
	20401	Black	50
	20501	Gold	50
	20601	Bronze	50

Cotton Twisted Cable

	28001	White	50
--	-------	-------	----

Telephone Twisted Cable



Silk Twisted Cable

	Code	Colour	Section	m
	30001	White	2x0.25	50
	30101	Ivory	2x0.25	50
	30201	Grey	2x0.25	50
	30301	Brown	2x0.25	50
	30401	Black	2x0.25	50
	30501	Gold	2x0.25	50
	30601	Bronze	2x0.25	50

Cotton Twisted Cable

	38001	White	2x0.75	50
--	-------	-------	--------	----

Round Cable



Silk Round Cable

	Code	Colour	Section	m
	22016	White	2x0.75	50
	22116	Ivory	2x0.75	50
	22216	Grey	2x0.75	50
	22316	Brown	2x0.75	50
	22416	Black	2x0.75	50
	22516	Gold	2x0.75	50
	22616	Bronze	2x0.75	50

Cotton Round Cable

	22716	White	2x0.75	50
--	-------	-------	--------	----

Silk Round Cable

	Code	Colour	Section	m
	22018	White	3x0.75	50
	22118	Ivory	3x0.75	50
	22218	Grey	3x0.75	50
	22318	Brown	3x0.75	50
	22418	Black	3x0.75	50
	22518	Gold	3x0.75	50
	22618	Bronze	3x0.75	50
	22715	Blue	3x0.75	50
	22818	Red	3x0.75	50
	22918	Dark Grey	3x0.75	50
	22A18	Red/Black	3x0.75	50
	22B18	White/Black	3x0.75	50
	22C18	Bronze/Black	3x0.75	50
	22D18	Green	3x0.75	50
	22E18	Jute	3x0.75	50

Cotton Round Cable







	22718	White	3x0.75	50
--	-------	-------	--------	----

Flat Cable



CE

Silk Flat Cable

	Code	Colour	Section	m
	24016	White	2x0.75	50
	24116	Ivory	2x0.75	50
	24216	Grey	2x0.75	50
	24316	Brown	2x0.75	50
	24416	Black	2x0.75	50
	24516	Gold	2x0.75	50
	24616	Bronze	2x0.75	50















Cotton Flat Cable

	24716	White	2x0.75	50
---	-------	-------	--------	----

























CE







Silk Round Cable - Blister 10 m







	Code	Colour	Section	m
	22018.B10	White	3x0.75	10
	22118.B10	Ivory	3x0.75	10
	22218.B10	Grey	3x0.75	10
	22318.B10	Brown	3x0.75	10
	22418.B10	Black	3x0.75	10
	22518.B10	Gold	3x0.75	10
	22618.B10	Bronze	3x0.75	10
	22715.B10	Blue	3x0.75	10
	22818.B10	Red	3x0.75	10
	22918.B10	Dark Grey	3x0.75	10
	22A18.B10	Red/Black	3x0.75	10
	22B18.B10	White/Black	3x0.75	10
	22C18.B10	Bronze/Black	3x0.75	10
	22D18.B10	Green	3x0.75	10
	22E18.B10	Jute	3x0.75	10

Silk Round Cable - Blister 3 m

	Code	Colour	Section	m
	22018.B3	White	3x0.75	3
	22118.B3	Ivory	3x0.75	3
	22218.B3	Grey	3x0.75	3
	22318.B3	Brown	3x0.75	3
	22418.B3	Black	3x0.75	3
	22518.B3	Gold	3x0.75	3
	22618.B3	Bronze	3x0.75	3
	22715.B3	Blue	3x0.75	3
	22818.B3	Red	3x0.75	3
	22918.B3	Dark Grey	3x0.75	3
	22A18.B3	Red/Black	3x0.75	3
	22B18.B3	White/Black	3x0.75	3
	22C18.B3	Bronze/Black	3x0.75	3
	22D18.B3	Green	3x0.75	3
	22E18.B3	Jute	3x0.75	3





		Wooden Wall Plate Ø 60 Dimpled Edge			
CODE	FINISH	DATA	PCS/PACK.		
01100	 Oak	 Ø 75 - Ø 85 mm	2		
01102	 Walnut				
01104	 White				
01106	 Raw				
01108	 Copper				

		Wooden Wall Plate Ø 80 Dimpled Edge			
CODE	FINISH	DATA	PCS/PACK.		
01110	 Oak	 Ø 95 - Ø 105 mm	2		
01112	 Walnut				
01114	 White				
01116	 Raw				
01118	 Copper				

		Wooden Wall Plate Ø 100 Dimpled Edge			
CODE	FINISH	DATA	PCS/PACK.		
01120	 Oak	 Ø 110 - Ø 125 mm	2		
01122	 Walnut				
01124	 White				
01126	 Raw				
01128	 Copper				







Wooden Wall Plate Ø 60 Round Edge

CODE	FINISH	DATA	PCS/PACK.
01101	 Oak	 Ø 75 - Ø 85 mm	2
01103	 Walnut		
01105	 White		
01107	 Raw		
01109	 Copper		

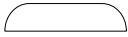





Wooden Wall Plate Ø 80 Round Edge

CODE	FINISH	DATA	PCS/PACK.
01111	 Oak	 Ø 95 - Ø 105 mm	2
01113	 Walnut		
01115	 White		
01117	 Raw		
01119	 Copper		

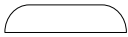







Wooden Wall Plate Ø 100 Round Edge

CODE	FINISH	DATA	PCS/PACK.
01121	 Oak	 Ø 110 - Ø 125 mm	2
01123	 Walnut		
01125	 White		
01127	 Raw		
01129	 Copper		









**Wooden Wall Plate for 2 Elements
Dimpled Edge**











CODE	FINISH	DATA	PCS/PACK.
01130	 Oak	 Ø 75 - Ø 85 mm	2
01132	 Walnut		
01134	 White		
01136	 Raw		
01138	 Copper		













**Wooden Wall Plate for 2 Elements
Round Edge**

CODE	FINISH	DATA	PCS/PACK.
01131	 Oak	 Ø 95 - Ø 105 mm	2
01133	 Walnut		
01135	 White		
01137	 Raw		
01139	 Copper		



		Insulator Ø 19 Screws and dowels included			
CODE	FINISH	DATA	PCS/PACK.		
01200	 White	 Ø 19 - h 24 mm	50		
01202	 Brown				
01203	 Antracite Raw				
01204	 Polished Black	 Ø 19 - h 24 mm	25		
36801	 White				
36803	 Brown				

		Insulator Ø 16 Screws and Dowels for Insulators			
CODE	FINISH	DATA	PCS/PACK.		
01210	 White	 Ø 16 - h 23 mm	50		











		Screws and Dowels for Insulators			
CODE	FINISH	DATA	PCS/PACK.		
01301	 Burnished Screws	tassello Ø 5	25		
01302	 Golden Screws				
01303	 Coppery Screws				
01304	 Chrome Screws				

CODE	FINISH	DATA	PCS/PACK.
 <p>Insulator Ø 19 Coloured Screws and Dowels Included</p> 			
660061.01	 White	 Ø 19 - h 24 mm	1
 <p>Cable Entry</p> 			
CODE	SIZES	DATA	PCS/PACK.
01400	Ø 16	 Ø 16/24 - Ø 20/30 - h 23 mm	10
01410	Ø 20		
01420	Ø 25		
 <p>Decentralizer</p>			
CODE	FINISH	DATA	PCS/PACK.
660059.07	 White	Ø 12 mm h 30 mm IP20 ☐	1
660059.06	 Chrome		
660059.05	 Brushed Bronzed		
 <p>Brass Cable Clamp Suitable for twisted cables 2x0.75 - 2x1 - 2x1.5 - 3x0.75 - 3x1 and Round Cables 3x0.75</p>			
CODE	FINISH	DATA	PCS/PACK.
660063.07	 Matt white	Ø20 - h15 mm	1
660063.09	 Matt Black		
660063.06	 Brushed Chrome		
660063.05	 Brushed Bronzed		



Door bell 12V gold



CODE	FINISH	DATA	PCS/PACK.
01800	 Oak/Gold Wooden wall - Dimpled Edge	 81 - 168 mm €€	1
01802	 Walnut/Gold Wooden wall - Dimpled Edge		
01804	 Bianca/Gold Wooden wall - Dimpled Edge		
01806	 Raw/Gold Wooden wall - Dimpled Edge		
01801	 Oak/Gold Wooden wall - Round Edge	 81 - 168 mm €€	
01803	 Walnut/Gold Wooden wall - Round Edge		
01805	 Bianca/Gold Wooden wall - Round Edge		
01807	 Raw/Gold Wooden wall - Round Edge		



Door bell 12V chrome



CODE	FINISH	DATA	PCS/PACK.
01810	 Oak/Chrome Wooden wall - Dimpled Edge	 81 - 168 mm €€	1
01812	 Walnut/Chrome Wooden wall - Dimpled Edge		
01814	 Bianca/Chrome Wooden wall - Dimpled Edge		
01816	 Raw/Chrome Wooden wall - Dimpled Edge		
01811	 Oak/Chrome Wooden wall - Round Edge	 81 - 168 mm €€	
01813	 Walnut/Chrome Wooden wall - Round Edge		
01815	 Bianca/Chrome Wooden wall - Round Edge		
01817	 Raw/Chrome Wooden wall - Round Edge		



The grace of heaven
may cause his work to
blossom into art

Walter Gropius
Bauhaus Manifesto





fusion

Porcelain and Brass

It is a precious collection, characterized by bases and distribution pipes in burnished brass. It also ensure **durability and safety for the entire system.**

An elegant and distinctive style, perfect for villas, farmhouses, modern locations and accommodations. It creates unique and suggestive contrasts, able to pleasantly surprise those who look at them.

A variable and inimitable patina

To allows the brass to “breathe”, we decided not to apply a transparent varnish. Instead, we opted for a **final wax finish**, a treatment that allows a slow and uneven oxidation of the surfaces, and favours a unique and fascinating development of the patina.



Perfect installations

Each brass component is designed to make the installation simple and precise. The basis are equipped with access provisions for pipes or joints; the pipes in turn are designed to be installed in cascade without the aid of any joints, facilitating assembly and guaranteeing a safe Connection.

Games of contrast

Versatile, aesthetically pleasing and **safe** for rustic environments. The contrast between the **burnished brass system** and the **polished white porcelain** creates a rather intriguing look, which evokes the steampunk style.

→ preview





**Rotary one-way/two-way
Push Button Switch**

CODE	TYPE	DATA	PCS/PACK.
31.100.14	Rotary one-way/two-way	* ØF 16 Ø 80 h 75 mm 1P 2 vie 10AX 250V~ IP20 CE	1
31.120.14	Rotary Push Button Switch	* ØF 16 Ø 80 h 75 mm 1P 10A 250V~ IP20 CE	1



Push Button

CODE	FINISH	DATA	PCS/PACK.
31.130.51	Burnished	* ØF 16 Ø 80 h 65 mm 1P 2A 12V~ IP20 CE	1



Socket-outlet

CODE	TYPE	DATA	PCS/PACK.
31.200.00	Italian Standard	* ØF 16 Ø 80 h 55 mm P11/P17 10-16A 250V~ IP20 CE	1



UNEL Socket-outlet

CODE	TYPE	DATA	PCS/PACK.
31.210.00	European Standard	* ØF 16 Ø 88 h 57 mm P30/P11 16A 250V~ IP20 CE	1

(*) ØF is the diameter in mm referring to the hole in the brass base.



Schuko Socket-outlet

CODE	TYPE	DATA	PCS/PACK.
31.255.00	German Standard	* $\varnothing F 16 \mid \varnothing 88 \mid h 57 \text{ mm}$ 16A 250V~ IP20 CE	1



French Socket-outlet

CODE	TYPE	DATA	PCS/PACK.
31.254.00	French Standard	* $\varnothing F 16 \mid \varnothing 88 \mid h 57 \text{ mm}$ 16A 250V~ IP20 CE	1



English Socket-outlet

CODE	TYPE	DATA	PCS/PACK.
31.253.00	British Standard	* $\varnothing F 16 \mid \varnothing 88 \mid h 57 \text{ mm}$ 13A 250V~ IP20 CE	1



Telephone Socket

CODE	TYPE	DATA	PCS/PACK.
31.220.00	RJ 11 6P	* $\varnothing F 16 \mid \varnothing 80 \mid h 55 \text{ mm}$ 6P/4C RJ 11 IP20 CE	1



Data Socket

CODE	TYPE	DATA	PCS/PACK.
31.230.00	RJ 45 Unshielded	* $\varnothing F 16 \mid \varnothing 80 \mid h 55 \text{ mm}$ C.5E UTP T568A – B IP20 CE	1

(*) $\varnothing F$ is the diameter in mm referring to the hole in the brass base.

	Coaxial TV connector - Female		
CODE	TYPE	DATA	PCS/PACK.
31.240.00	Female TV	* ØF 16 Ø 80 h 60 mm ----- Ø 9.5 femmina ----- IP20 €	1

	Coaxial TV Connector - Male		
CODE	TYPE	DATA	PCS/PACK.
31.241.00	Male TV	* ØF 16 Ø 80 h 60 mm ----- Ø 9.5 maschio ----- IP20 €	1

	Sat Socket		
CODE	TYPE	DATA	PCS/PACK.
31.242.00	SAT connector	* ØF 16 Ø 80 h 60 mm ----- IP20 €	1

	Junction Box		
CODE	TYPE	DATA	PCS/PACK.
31.510.00	Ø 105	* ØF 20 Ø 105 h 70 mm ----- IP20 €	1

(*) ØF is the diameter in mm referring to the hole in the brass base.





Tube

CODE	TYPE	DATA	PCS/PACK.
31.905.00	Tube Ø 12	Ø M12 F12 1000 mm	1
31.906.00	Tube Ø 16	Ø M16 F16 1000 mm	
31.907.00	Tube Ø 20	Ø M20 F20 1000 mm	



Joint Reduction

CODE	TYPE	DATA	PCS/PACK.
31.908.00	Joint Reduction 12-16	Ø M16 F12 35 mm	1
31.909.00	Joint Reduction 12-20	Ø M20 F12 35 mm	
31.910.00	Joint Reduction 16-20	Ø M20 F16 35 mm	
31.923.00	Joint Reduction 20-16	Ø F20 M16 35 mm	



Tube Connection

CODE	TYPE	DATA	PCS/PACK.
31.911.00	Tube Connection Ø 12	Ø F12 F12 30 mm	1
31.912.00	Tube Connection Ø 16	Ø F16 F16 30 mm	
31.913.00	Tube Connection Ø 20	Ø F20 F20 30 mm	



Curve 90°

CODE	FINISH	DATA	PCS/PACK.
31.914.00	Curve Ø 12	Ø M12 F12 Ø12 65 x 65 mm	1
31.915.00	Curve Ø 16	Ø M16 F16 Ø16 65 x 65 mm	
31.916.00	Curve Ø 20	Ø M20 F20 Ø20 80 x 80 mm	



Clip for tube/wall support

CODE	TYPE	DATA	PCS/PACK.
31.917.00	Clip Ø 12	Ø 12 41 h 17 mm	1
31.918.00	Clip Ø 16	Ø 16 41 h 21 mm	
31.919.00	Clip Ø 20	Ø 20 41 h 22 mm	



T-Joint

CODE	TYPE	DATA	PCS/PACK.
31.920.00	T-Joint Ø 12	Ø FFF12 Ø 12 25 h 34 mm	1
31.921.00	T-Joint Ø 16	Ø FFF16 Ø 16 31 h 40 mm	
31.922.00	T-Joint Ø 20	Ø FFF20 Ø 20 38 h 58 mm	



Ceiling Lighting Ventaglio

CODE	TYPE	DATA	PCS/PACK.
02101.04	Lighting Ø 180	<p>CEILING</p> <p>* ØF20 Ø 105 h 70 mm</p> <p>LIGHTING</p> <p>Ø 180 h 200 mm</p>	1
02111.04	Lighting Ø 280	<p>CEILING</p> <p>* ØF 20 Ø 105 h 70 mm</p> <p>LIGHTING</p> <p>Ø 280 h 220 mm</p>	
02151.04	Lighting Ø 400	<p>CEILING</p> <p>* ØF 20 Ø 105 h 70 mm</p> <p>LIGHTING</p> <p>Ø 400 h 220 mm</p>	



Ceiling Lighting Godet

CODE	TYPE	DATA	PCS/PACK.
02001.04	Lighting Ø 180	<p>CEILING</p> <p>* ØF 20 Ø 105 h 70 mm</p> <p>LIGHTING</p> <p>Ø 180 h 200 mm</p>	1
02011.04	Lighting Ø 280	<p>CEILING</p> <p>* ØF 20 Ø 105 h 70 mm</p> <p>LIGHTING</p> <p>Ø 280 h 220 mm</p>	

(*) ØF is the diameter in mm referring to the hole in the brass base.



Suspension Lighting
Ventaglio

CODE	TYPE	DATA	PCS/PACK.				
03101.04	Lighting Ø 180	<table border="1"> <tr><td>CEILING</td></tr> <tr><td>* ØF 20 Ø 105 h 70 mm</td></tr> <tr><td>LIGHTING</td></tr> <tr><td>Ø 180 h 1020 mm</td></tr> </table>	CEILING	* ØF 20 Ø 105 h 70 mm	LIGHTING	Ø 180 h 1020 mm	1
CEILING							
* ØF 20 Ø 105 h 70 mm							
LIGHTING							
Ø 180 h 1020 mm							
03111.04	Lighting Ø 280	<table border="1"> <tr><td>CEILING</td></tr> <tr><td>* ØF 20 Ø 105 h 70 mm</td></tr> <tr><td>LIGHTING</td></tr> <tr><td>Ø 280 h 1030 mm</td></tr> </table>	CEILING	* ØF 20 Ø 105 h 70 mm	LIGHTING	Ø 280 h 1030 mm	
CEILING							
* ØF 20 Ø 105 h 70 mm							
LIGHTING							
Ø 280 h 1030 mm							
03151.04	Lighting Ø 400	<table border="1"> <tr><td>CEILING</td></tr> <tr><td>* ØF 20 Ø 105 h 70 mm</td></tr> <tr><td>LIGHTING</td></tr> <tr><td>Ø 400 h 1030 mm</td></tr> </table>	CEILING	* ØF 20 Ø 105 h 70 mm	LIGHTING	Ø 400 h 1030 mm	
CEILING							
* ØF 20 Ø 105 h 70 mm							
LIGHTING							
Ø 400 h 1030 mm							



Suspension Lighting
Godet

CODE	TYPE	DATA	PCS/PACK.				
03001.04	Lighting Ø 180	<table border="1"> <tr><td>CEILING</td></tr> <tr><td>* ØF 20 Ø 105 h 70 mm</td></tr> <tr><td>LIGHTING</td></tr> <tr><td>Ø 180 h 1030 mm</td></tr> </table>	CEILING	* ØF 20 Ø 105 h 70 mm	LIGHTING	Ø 180 h 1030 mm	1
CEILING							
* ØF 20 Ø 105 h 70 mm							
LIGHTING							
Ø 180 h 1030 mm							
03011.04	Lighting Ø 280	<table border="1"> <tr><td>CEILING</td></tr> <tr><td>* ØF 20 Ø 105 h 70 mm</td></tr> <tr><td>LIGHTING</td></tr> <tr><td>280 h 1040 mm</td></tr> </table>	CEILING	* ØF 20 Ø 105 h 70 mm	LIGHTING	280 h 1040 mm	
CEILING							
* ØF 20 Ø 105 h 70 mm							
LIGHTING							
280 h 1040 mm							

(*) ØF is the diameter in mm referring to the hole in the brass base.

CODE	TYPE	DATA	PCS/PACK.	
 <p>Applique with Porcelain Plate Ventaglio</p>				
07101.04	Ventaglio Ø 180	<p><u>CEILING</u></p> <p>* ØF 20 Ø 105 h 70 mm</p> <p><u>LIGHTING</u></p> <p>Ø 180 270 mm h 200 mm</p>	1	
 <p>Applique with Porcelain Plate Godet</p>				
07001.04	Godet Ø 180	<p><u>CEILING</u></p> <p>* ØF 20 Ø 105 h 70 mm</p> <p><u>LIGHTING</u></p> <p>Ø 180 270 mm h 200 mm</p>	1	
<p>Applique with Glass</p>				
	CODE	DATA	PCS/PACK.	
	07201.04	Mimosa	<p><u>CEILING</u></p> <p>* ØF 20 Ø 105 h 70 mm</p> <p><u>LIGHTING</u></p> <p>Ø 180 270 mm h 200 mm</p>	
	07221.04	Iris	<p><u>CEILING</u></p> <p>* ØF 20 Ø 105 h 70 mm</p> <p><u>LIGHTING</u></p> <p>Ø 280 270 mm h 200 mm</p>	1
	07231.04	Girasole	<p><u>CEILING</u></p> <p>* ØF 20 Ø 105 h 70 mm</p> <p><u>LIGHTING</u></p> <p>Ø 400 270 mm h 200 mm</p>	

(*) ØF is the diameter in mm referring to the hole in the brass base.



arreda

Free
yourself from
everything
that is taken
for granted

Design is a labor
of love for life

Gio Ponti
Architect



The elegance
and simplicity
of a unique style
that makes your
home unique



The combination that most represents us

A range of colours and finishes for any customized solution.



















→ preview





Round Plates

FINISH	CODE	CODE	CODE	CODE	PCS/PACK.
 White Porcelain	23.421.PR	23.422.PR	23.423.PR	---	1
 Wengè Wood	23.321.WG	23.322.WG	23.323.WG	23.324.WG	
 Warm Nut Wood	23.321.WN	23.322.WN	23.323.WN	23.324.WN	1
 Dove Gray Wood	23.321.DG	23.322.DG	23.323.DG	23.324.DG	

		Rotary one-way/two-way Push button Switch			
CODE	FINISH	DATA	PCS/PACK.		
20.110.10	 Porcelain Two-Way Switch	 52 - 52 h 50.5 mm 1P 2 vie 10AX 250V~ For European standard junction box IP20 CE	1		
20.110.11	 Antique Gold Two-Way Switch				
20.110.12	 Antique Chrome Two-Way Switch				
20.110.13	 Antique Copper Two-Way Switch				
20.110.14	 Antique Copper Two-Way Switch				
20.120.10	 Porcelain Push Button Switch	 52 - 52 h 50.5 mm 1P 10A 250V~ For European standard junction box IP20 CE	1		
20.120.11	 Antique Gold Push Button Switch				
20.120.12	 Antique Chrome Push Button Switch				
20.120.13	 Antique Copper Push Button Switch				
20.120.14	 Bronze Push Button Switch				
		Push Button			
CODE	FINISH	DATA	PCS/PACK.		
20.130.51	 Polished Gold	 52 - 52 mm 1P 2A 12V~ For European standard junction box IP20 CE	1		
20.130.52	 Matt Chrome				

CODE	TYPE	DATA	PCS/PACK.
	Socket-outlet		
20.200.00	 Italian Standard	52 - 52 mm P11/P17 10-16A 250V~ For European standard junction box IP20 CE	1
	UNEL Socket-outlet		
20.210.00	 Standard Europeo	52 - 52 mm P30/P11 16A 250V~ For European standard junction box IP20 CE	1
	Schuko Socket-outlet		
20.252.00	 German Standard	52 - 52 mm 16A 250V~ For European standard junction box IP20 CE	1
	French Socket-outlet		
20.254.00	 French Standard	52 - 52 mm 16A 250V~ For European standard junction box IP20 CE	1

CODE	TYPE	DATA	PCS/PACK.
Telephone Socket			
20.220.00	 RJ 11 6P	52 - 52 mm 6P/4C RJ 11 For European standard junction box IP20 CE	1
Data Socket			
20.230.00	 RJ45 unshielded	52 - 52 mm C.5E UTP T568A - B For European standard junction box IP20 CE	1
Coaxial TV Connector - SAT			
20.240.00	 Coaxial TV/SAT	52 - 52 mm TV/SAT Mux For European standard junction box IP20 CE	1

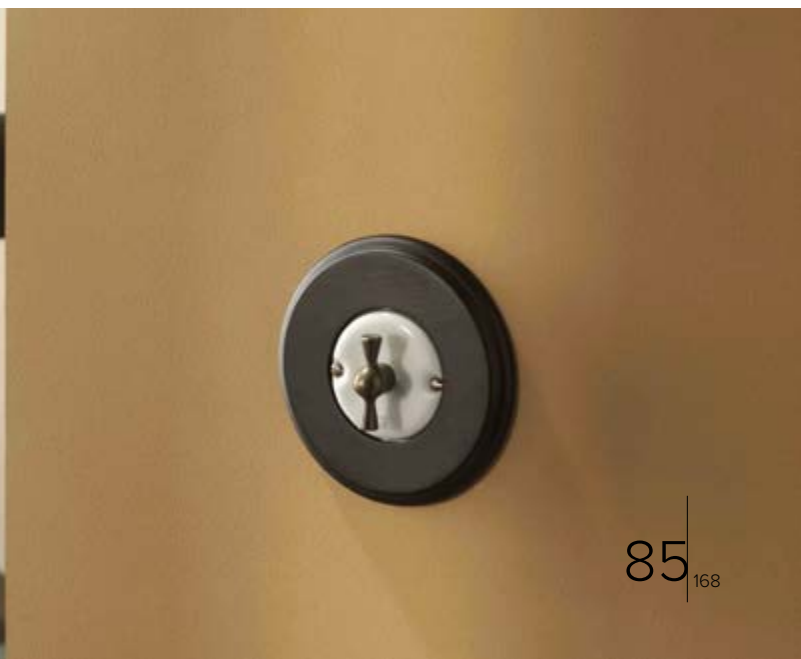
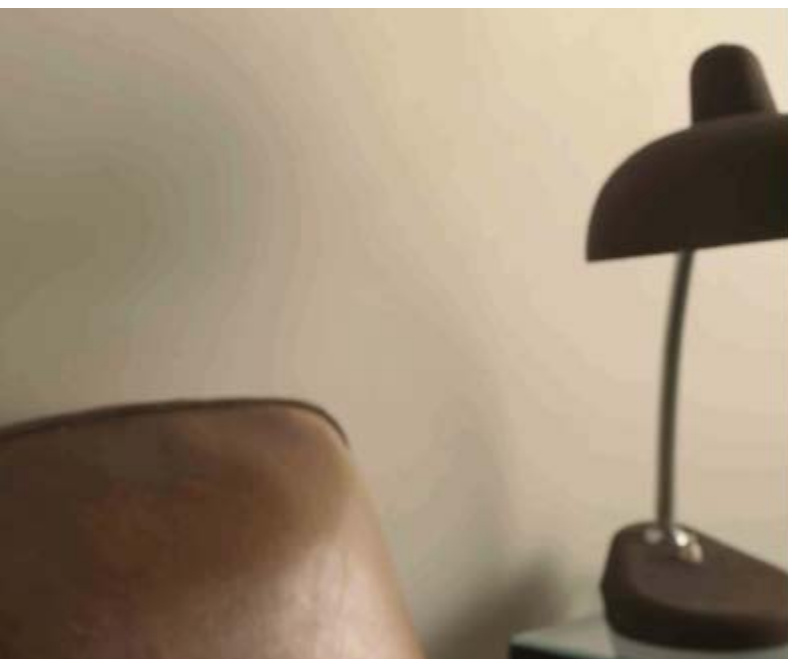















Square Plates

FINISH					PCS/PACK.
	CODE	CODE	CODE	CODE	
MINT Polished / Bright	15.111.ML	15.112.ML	15.113.ML	---	1
VANILLA Polished / Bright	15.111.VL	15.112.VL	15.113.VL	---	
STONE Chrome / Matt	15.111.SM	15.112.SM	15.113.SM	---	
CHERRY Polished / Bright	15.111.CL	15.112.CL	15.113.CL	---	
BLACK Polished / Bright	15.111.BL	15.112.BL	15.113.BL	---	
Wengè Wood	15.311.WG	15.312.WG	15.313.WG	15.314.WG	1
City Gray Wood	15.311.CG	15.312.CG	15.313.CG	15.314.CG	
Early Brass Brass	15.211.EB	15.212.EB	15.213.EB	15.214.EB	1
Early Brass Chrome	15.211.EC	15.212.EC	15.213.EC	15.214.EC	



Rotary one-way/two-way Push button Switch







CODE	FINISH	DATA	PCS/PACK.
10.110.10	 Butterfly Porcelain one-way/two-way Switch	 <p>52 - 52 h 50.5 mm</p> <hr/> <p>1P 2 vie</p> <hr/> <p>10AX 250V~</p> <hr/> <p>For European standard junction box</p> <hr/> <p>IP20 CE</p>	1
10.110.11	 Butterfly Gold one-way/two-way Switch		
10.110.12	 Butterfly Chrome one-way/two-way Switch		
10.110.14	 Butterfly Bronze one-way/two-way Switch		
10.110.00	 Moon Porcelain one-way/two-way Switch		
10.120.10	 Butterfly Porcelain push button Switch	 <p>52 - 52 h 50.5 mm</p> <hr/> <p>1P 10A 250V~</p> <hr/> <p>For European standard junction box</p> <hr/> <p>IP20 CE</p>	1
10.120.11	 Butterfly Gold push button Switch		
10.120.12	 Butterfly Chrome push button Switch		
10.120.14	 Butterfly Bronze push button Switch		
10.120.00	 Moon Porcelain push button Switch		



**Rotary one-way/two-way
Push button Switch**

CODE	FINISH	DATA	PCS/PACK.	
10.110.60		Compass Porcelain one-way/two-way Switch	 52 - 52 h 50.5 mm 1P 2 vie 10AX 250V~ For European standard junction box IP20 CE	1
10.110.61		Compass Antique Brass one-way/two-way Switch		
10.110.62		Compass Antique Chrome one-way/two-way Switch		
10.110.80		Brick Porcelain one-way/two-way Switch		
10.110.81		Brick Antique Brass one-way/two-way Switch		
10.110.82		Brick Antique Chrome push button Switch		
10.110.70		Rhombus Porcelain one-way/two-way Switch		
10.120.60		Compass Porcelain push button Switch	 52 - 52 h 50.5 mm 1P 10A 250V~ For European standard junction box IP20 CE	1
10.120.61		Compass Antique Brass push button Switch		
10.120.62		Compass Antique Chrome push button Switch		
10.120.80		Brick Porcelain push button Switch		
10.120.81		Brick Antique Brass push button Switch		
10.120.82		Brick Antique Chrome push button Switch		
10.120.70		Rhombus Porcelain push button Switch		



		Push Button		
CODE	FINISH	DATA	PCS/PACK.	
10.130.51	 Polished Gold	 52 - 52 mm 1P 2A 12V~ For European standard junction box IP20 CE	1	
10.130.52	 Matt Chrome			
		Socket-outlet		
CODE	TYPE	DATA	PCS/PACK.	
10.200.00	 Italian Standard	52 - 52 mm P11/P17 10-16A 250V~ For European standard junction box IP20 CE	1	
		UNEL Socket-outlet		
CODE	TYPE	DATA	PCS/PACK.	
10.210.00	 European Standard	52 - 52 mm P30/P11 16A 250V~ For European standard junction box IP20 CE	1	
		Schuko Socket-outlet		
CODE	TYPE	DATA	PCS/PACK.	
10.252.00	 German Standard	52 - 52 mm 16A 250V~ For European standard junction box IP20 CE	1	



French Socket-outlet

CODE

TYPE

DATA

PCS/PACK.

10.254.00



French Standard

52 - 52 mm

16A | 250V~

For European standard
junction box

IP20 | CE

1



Telephone Socket

CODE

TYPE

DATA

PCS/PACK.

10.220.00



RJ 11 6P

52 - 52 mm

6P/4C | RJ 11

For European standard
junction box

IP20 | CE

1



Data Socket

CODE

TYPE

DATA

PCS/PACK.

10.230.00



RJ45 unshielded

52 - 52 mm

C.5E | UTP | T568A - B

For European standard
junction box

IP20 | CE

1



Coaxial TV Connector - SAT

CODE

TYPE

DATA

PCS/PACK.

10.240.00



Coaxial TV/SAT

52 - 52 mm

TV/SAT Mux

For European standard
junction box

IP20 | CE

1

The purpose
of architecture
is to move

Le Corbusier
Architect





Lighting

lamp 30's

The goal of the lighting, applique and abat-jour collection is to bring the vintage style of the 1930s back to life. At that time electrical systems were mainly visible and the lighting fixtures had distinctive styles, such as our Godet or Ventaglio models, which are assembled with gold, chrome and antique copper accessories.

Our collection brings back to memory that image that has never been lost, allowing you to rediscover **the warmth and welcome of tradition.**



→ preview



→ **Kit 30's** - Lamp 30's Ceiling Cups and Plates













**Ceiling Lighting
Godet**





CODE	FINISH	DATA	PCS/PACK.
02001	 Gold	Ø 180 h 200 mm MAX 60W E27 50/60 Hz 250V~ IP20 ☼	1
02001.02	 Chrome		
02001.03	 Copper		
02011	 Gold	Ø 280 h 220 mm MAX 60W E27 50/60 Hz 250V~ IP20 ☼	
02011.02	 Chrome		
02011.03	 Copper		



**Ceiling Lighting
Godet Rigo Oro**











CODE	FINISH	DATA	PCS/PACK.
02031	 Gold	Ø 180 h 200 mm MAX 60W E27 50/60 Hz 250V~ IP20 ☼	1
02041	 Gold	Ø 280 h 220 mm MAX 60W E27 50/60 Hz 250V~ IP20 ☼	

Choose the combination of ceiling cups and plates from page 120 to page 125 (included in the price)



Ceiling Lighting
Ventaglio



CODE	FINISH	DATA	PCS/PACK.
02101	 Gold	Ø 180 h 200 mm MAX 60W E27 50/60 Hz 250V~ IP20 ☼	1
02101.02	 Chrome		
02101.03	 Copper		
02111	 Gold	Ø 280 h 220 mm MAX 60W E27 50/60 Hz 250V~ IP20 ☼	
02111.02	 Chrome		
02111.03	 Copper		
02151	 Gold	Ø 400 h 220 mm MAX 60W E27 50/60 Hz 250V~ IP20 ☼	
02151.02	 Chrome		
02151.03	 Copper		

Choose the combination of ceiling cups and plates from page 120 to page 125 (included in the price)



Ceiling Lighting
Ventaglio Gocce Oro









CODE	FINISH	DATA	PCS/PACK.
02131	Gold	Ø 180 h 200 mm MAX 60W E27 50/60 Hz 250V~ IP20 CE	1
02141	Gold	Ø 280 h 220 mm MAX 60W E27 50/60 Hz 250V~ IP20 CE	
02161	Gold	Ø 400 h 220 mm MAX 60W E27 50/60 Hz 250V~ IP20 CE	

Choose the combination of ceiling cups and plates from page 120 to page 125 (included in the price)



Suspension Lighting
Godet











CODE	FINISH	DATA	PCS/PACK.
03001	 Gold	Ø 180 h 1030 mm MAX 60W E27 50/60 Hz 250V~ IP20 €	1
03001.02	 Chrome		
03001.03	 Copper		
03011	 Gold	Ø 280 h 1040 mm MAX 60W E27 50/60 Hz 250V~ IP20 €	
03011.02	 Chrome		
03011.03	 Copper		

Choose the combination of ceiling cups and plates from page 120 to page 125 (included in the price)



Suspension Lighting Ventaglio



CODE	FINISH	DATA	PCS/PACK.
03101	 Gold	Ø 180 h 1020 mm MAX 60W E27 50/60 Hz 250V~ IP20 ☼	1
03101.02	 Chrome		
03101.03	 Copper		
03111	 Gold	Ø 280 h 1030 mm MAX 60W E27 50/60 Hz 250V~ IP20 ☼	
03111.02	 Chrome		
03111.03	 Copper		
03151	 Gold	Ø 400 h 1030 mm MAX 60W E27 50/60 Hz 250V~ IP20 ☼	
03151.02	 Chrome		
03151.03	 Copper		

Choose the combination of ceiling cups and plates from page 120 to page 125 (included in the price)



Suspension Lighting
Ventaglio Gocce Oro



CODE	FINISH	DATA	PCS/PACK.
03131	Gold	Ø 180 h 1020 mm MAX 60W E27 50/60 Hz 250V~ IP20 ☼	1
03141	Gold	Ø 280 h 1030 mm MAX 60W E27 50/60 Hz 250V~ IP20 ☼	
03161	Gold	Ø 400 h 1030 mm MAX 60W E27 50/60 Hz 250V~ IP20 ☼	



Suspension Lighting
Godet Filo Oro



CODE	FINISH	DATA	PCS/PACK.
03031	Gold	Ø 180 h 1030 mm MAX 60W E27 50/60 Hz 250V~ IP20 ☼	1
03041	Gold	Ø 280 h 1040 mm MAX 60W E27 50/60 Hz 250V~ IP20 ☼	

Choose the combination of ceiling cups and plates from page 120 to page 125 (included in the price)



**Suspension Lighting
Antique Gocce Oro**



CODE

FINISH

DATA

PCS/PACK.

03211

Gold

Ø 400 | h 110 mm

MAX 60W | E27

50/60 Hz | 250V~

IP20 | CE

1

Choose the combination of ceiling cups and plates from page 120 to page 125 (included in the price)





Up Down Lighting
Ventaglio



CODE	FINISH	DATA	PCS/PACK.
04101	Gold	Ø 180 h min 720 mm h max 1638 mm MAX 60W E27 50/60 Hz 250V~ IP20 €€	1
04111	Gold	Ø 280 h min 740 mm h max 1640 mm MAX 60W E27 50/60 Hz 250V~ IP20 €€	
04151	Gold	Ø 400 h min 740 mm h max 1640 mm MAX 60W E27 50/60 Hz 250V~ IP20 €€	



Up Down Lighting
Godet



CODE	FINISH	DATA	PCS/PACK.
04001	Gold	Ø 180 h min 730 mm h max 1648 mm MAX 60W E27 50/60 Hz 250V~ IP20 €€	1
04011	Gold	Ø 280 h min 750 mm h max 1650 mm MAX 60W E27 50/60 Hz 250V~ IP20 €€	

Choose the combination with the plates on page 126 (included in the price)



**Up Down Lighting
Ventaglio Gocce Oro**



CODE

FINISH

DATA

PCS/PACK.

04131



Gold

Ø 180 | h min 720 mm
h max 1638 mm
MAX 60W | E27
50/60 Hz | 250V~
IP20 | ☼

04141



Gold

Ø 280 | h min 740 mm
h max 1640 mm
MAX 60W | E27
50/60 Hz | 250V~
IP20 | ☼

04161



Gold

Ø 400 | h min 740 mm
h max 1640 mm
MAX 60W | E27
50/60 Hz | 250V~
IP20 | ☼

1



**Up Down Lighting
Godet Rigo Oro**



CODE

FINISH

DATA

PCS/PACK.

04031



Gold

Ø 180 | h min 730 mm
h max 1648 mm
MAX 60W | E27
50/60 Hz | 250V~
IP20 | ☼

04041



Gold

Ø 280 | h min 750 mm
h max 1650 mm
MAX 60W | E27
50/60 Hz | 250V~
IP20 | ☼

1

Choose the combination with the plates on page 126 (included in the price)



CODE

**Abatjour
Godet**
Switching on and off with 'chain' switch

FINISH



DATA

PCS/PACK.

06001



Gold

06001.02



Chrome

06001.03



Copper

Ø 180 | | 270 mm
h 200 mm

MAX 60W | E27
50/60 Hz | 250V~

IP20 | CE

1



CODE

**Abatjour
Godet Filo Oro**
Switching on and off with 'chain' Switch

FINISH



DATA

PCS/PACK.

06031



Gold

Ø 180 | | 270 mm
h 200 mm

MAX 60W | E27
50/60 Hz | 250V~

IP20 | CE

1

Choose the combination of ceiling cups and plates from page 120 to page 125 (included in the price)



**Abatjour
Ventaglio**
Switching on and off with 'chain' switch



CODE	FINISH	DATA	PCS/PACK.
06101	 Gold	Ø 180 270 mm h 200 mm <hr/> MAX 60W E27 50/60 Hz 250V~ <hr/> IP20 CE	1
06101.02	 Chrome		
06101.03	 Copper		



**Abatjour
Ventaglio Gocce Oro**
Switching on and off with 'chain' Switch





CODE	FINISH	DATA	PCS/PACK.
06131	 Gold	Ø 180 270 mm h 200 mm <hr/> MAX 60W E27 50/60 Hz 250V~ <hr/> IP20 CE	1

Choose the combination of ceiling cups and plates from page 120 to page 125 (included in the price)





**Abatjour
Mimosa**
Switching on and off with 'chain' switch

CODE	FINISH	DATA	PCS/PACK.
06201	 Gold	l 270 mm h 200 mm <hr/> MAX 60W E27 50/60 Hz 250V~ <hr/> IP20 ☑	1
06201.02	 Chrome		
06201.03	 Copper		





**Abatjour
Iris**
Switching on and off with 'chain' switch

CODE	FINISH	DATA	PCS/PACK.
06221	 Gold	270 mm h 200 mm <hr/> MAX 60W E27 50/60 Hz 250V~ <hr/> IP20 ☑	1
06221.02	 Chrome		
06221.03	 Copper		

Choose the combination of ceiling cups and plates from page 120 to page 125 (included in the price)













**Abatjour
Girasole**
Switching on and off with 'chain' switch

CODE	FINISH	DATA	PCS/PACK.
06231	 Gold	l 270 mm h 200 mm <hr/> MAX 60W E27 50/60 Hz 250V~ <hr/> IP20 CE	1
06231.02	 Chrome		
06231.03	 Copper		

Choose the combination of ceiling cups and plates from page 120 to page 125 (included in the price)



	Applique Godet		
CODE	FINISH	DATA	PCS/PACK.
07001	 Gold	Ø 180 270 mm h 200 mm <hr/> MAX 60W E27 50/60 Hz 250V~ <hr/> IP20 ☼	1
07001.02	 Chrome		
07001.03	 Copper		

	Applique Ventaglio		
CODE	FINISH	DATA	PCS/PACK.
07101	 Gold	Ø 180 270 mm h 200 mm <hr/> MAX 60W E27 50/60 Hz 250V~ <hr/> IP20 ☼	1
07101.02	 Chrome		
07101.03	 Copper		

Choose the combination of ceiling cups and plates from page 120 to page 125 (included in the price)

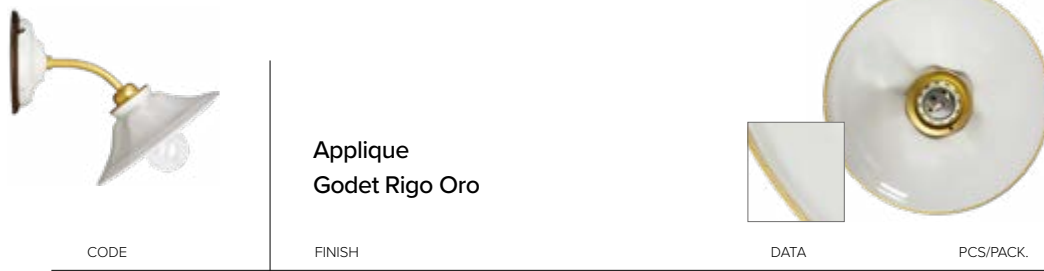

CODE

Applique Godet Rigo Oro

FINISH



DATA

PCS/PACK.

07031



Gold

Ø 180 | l 270 mm
h 200 mm

MAX 60W | E27
50/60 Hz | 250V~

IP20 | CE

1

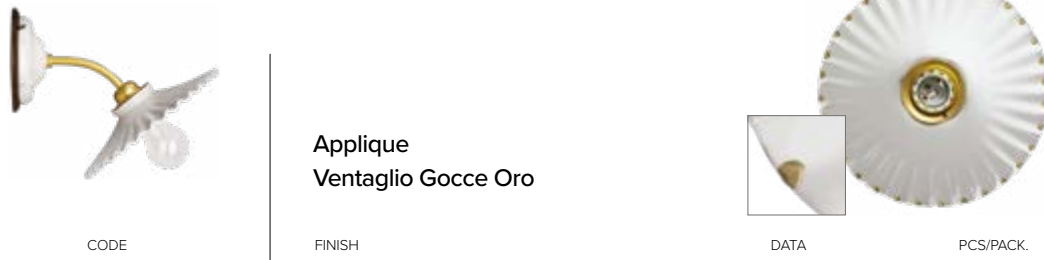

CODE

Applique Ventaglio Gocce Oro

FINISH



DATA

PCS/PACK.

07131



Gold

Ø 180 | l 270 mm
h 200 mm

MAX 60W | E27
50/60 Hz | 250V~

IP20 | CE

1

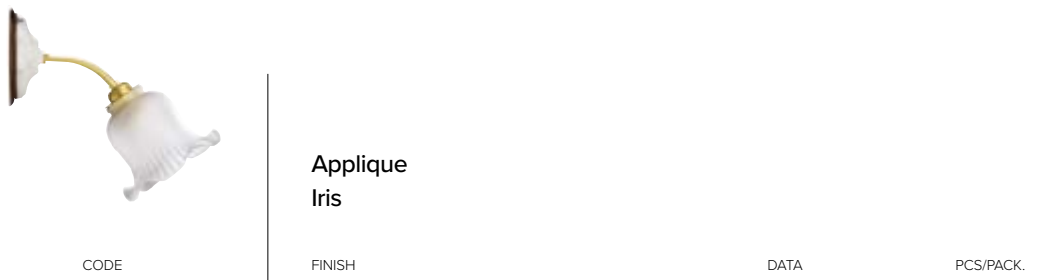

CODE

Applique Iris

FINISH

DATA

PCS/PACK.

07221



Gold

07221.02



Chrome

07221.03



Copper

l 270 mm | h 200 mm

MAX 60W | E27
50/60 Hz | 250V~

IP20 | CE



1

Choose the combination of ceiling cups and plates from page 120 to page 125 (included in the price)







Applique Mimosa

CODE	FINISH	DATA	PCS/PACK.
07201	 Gold	270 mm h 200 mm MAX 60W E27 50/60 Hz 250V~ IP20 ☼	1
07201.02	 Chrome		
07201.03	 Copper		



Applique Girasole

CODE	FINISH	DATA	PCS/PACK.
07231	 Gold	270 mm h 200 mm MAX 60W E27 50/60 Hz 250V~ IP20 ☼	1
07231.02	 Chrome		
07231.03	 Copper		

Choose the combination of ceiling cups and plates from page 120 to page 125 (included in the price)





Applique with Porcelain Arm Godet



CODE	DATA	PCS/PACK.
07301	\varnothing 180 170 mm h 180 mm MAX 60W E27 50/60 Hz 250V~ IP20 €	1
07311	\varnothing 280 330 mm h 220 mm MAX 60W E27 50/60 Hz 250V~ IP20 €	



Applique with Porcelain Arm Ventaglio



CODE	DATA	PCS/PACK.
07401	\varnothing 180 170 mm h 180 mm MAX 60W E27 50/60 Hz 250V~ IP20 €	1
07411	\varnothing 280 330 mm h 220 mm MAX 60W E27 50/60 Hz 250V~ IP20 €	







Applique with Porcelain Arm Godet Rigo Oro



CODE	DATA	PCS/PACK.
07331	\varnothing 180 170 mm h 180 mm MAX 60W E27 50/60 Hz 250V~ IP20 €	1
07341	\varnothing 280 330 mm h 220 mm MAX 60W E27 50/60 Hz 250V~ IP20 €	

Choose the combination with the plates on page 126 (included in the price)

	<p>Applique with Porcelain Arm Ventaglio Gocce Oro</p>	
CODE	DATA	PCS/PACK.

<p>07431</p> 	<p>Ø 180 l 170 mm h 180 mm MAX 60W E27 50/60 Hz 250V~ IP20 €€</p>	<p>1</p>
<p>07441</p> 	<p>Ø 280 330 mm h 220 mm MAX 60W E27 50/60 Hz 250V~ IP20 €€</p>	<p>1</p>

	<p>Applique with porcelain arm Mimosa</p>	
CODE	DATA	PCS/PACK.

<p>07501</p>	<p>l 270 mm h 200 mm MAX 60W E27 50/60 Hz 250V~ IP20 €€</p>	<p>1</p>
--------------	---	----------

	<p>Applique with porcelain arm Iris</p>	
CODE	DATA	PCS/PACK.

<p>07521</p>	<p>l 270 mm h 200 mm MAX 60W E27 50/60 Hz 250V~ IP20 €€</p>	<p>1</p>
--------------	---	----------

	<p>Applique with porcelain arm Girasole</p>	
CODE	DATA	PCS/PACK.

<p>07531</p>	<p>l 270 mm h 200 mm MAX 60W E27 50/60 Hz 250V~ IP20 €€</p>	<p>1</p>
--------------	---	----------

Choose the combination with the plates on page 126 (included in the price)





CODE

**Suspension Lighting
Bubble**

FINISH





DATA

PCS/PACK.

CODE	FINISH	DATA	PCS/PACK.
03301	 Gold	Ø 140 h 1110 mm GIRASOLE glass MAX 60W E27 50/60 Hz 250V~ IP20 ☼	1
03301.02	 Chrome	Ø 140 h 1110 mm GIRASOLE glass MAX 60W E27 50/60 Hz 250V~ IP20 ☼	
03301.03	 Copper	Ø 140 h 1110 mm GIRASOLE glass MAX 60W E27 50/60 Hz 250V~ IP20 ☼	











Wall lamp - Smooth

CODE	FINISH	DATA	PCS/PACK.
05011	 <p>Walnut Wall plate with Dimpled Edge</p>	<p>Ø 350 h 250 mm</p> <hr/> <p>MAX 60W E27</p> <hr/> <p>50/60 Hz 250V~</p> <hr/> <p>IP20 €€</p>	1
05013	 <p>Oak Wall plate with Dimpled Edge</p>	<p>Ø 350 h 250 mm</p> <hr/> <p>MAX 60W E27</p> <hr/> <p>50/60 Hz 250V~</p> <hr/> <p>IP20 €€</p>	
05012	 <p>Walnut Wall plate with round Edge</p>	<p>Ø 350 h 250 mm</p> <hr/> <p>MAX 60W E27</p> <hr/> <p>50/60 Hz 250V~</p> <hr/> <p>IP20 €€</p>	
05014	 <p>Oak Wall plate with round Edge</p>	<p>Ø 350 h 250 mm</p> <hr/> <p>MAX 60W E27</p> <hr/> <p>50/60 Hz 250V~</p> <hr/> <p>IP20 €€</p>	





Wall lamp - Decorated

CODE	FINISH	DATA	PCS/PACK.
05101	 Walnut Wall plate with Dimpled Edge	Ø 300 h 225 mm MAX 60W E27 50/60 Hz 250V~ IP20 €€	
05103	 Oak Wall plate with Dimpled Edge	Ø 300 h 225 mm MAX 60W E27 50/60 Hz 250V~ IP20 €€	
05111	 Walnut Wall plate with Dimpled Edge	Ø 350 h 250 mm MAX 60W E27 50/60 Hz 250V~ IP20 €€	
05113	 Oak Wall plate with Dimpled Edge	Ø 350 h 250 mm MAX 60W E27 50/60 Hz 250V~ IP20 €€	
05102	 Walnut Wall plate with round Edge	Ø 300 h 225 mm MAX 60W E27 50/60 Hz 250V~ IP20 €€	
05104	 Oak Wall plate with round Edge	Ø 300 h 225 mm MAX 60W E27 50/60 Hz 250V~ IP20 €€	
05112	 Walnut Wall plate with round Edge	Ø 350 h 250 mm MAX 60W E27 50/60 Hz 250V~ IP20 €€	
05114	 Oak Wall plate with round Edge	Ø 350 h 250 mm MAX 60W E27 50/60 Hz 250V~ IP20 €€	

1

















KIT 30'S



Ceiling cup - Smooth + Wall plate Dimpled Edge Ø 80

Ceiling lighting and suspension lighting with plate
Ø 180 - Ø 280

















CODE	FINISH	TYPE	PCS/PACK.
49001	 Walnut	WHITE ITALY	1
49003	 Oak		
49009	 White		
49011	 Raw		
49017	 Copper		
49001.01	 Walnut	ATLANTIS Base with 1 hole	1
49003.01	 Oak		
49009.01	 White		
49011.01	 Raw		
49017.01	 Copper		
49001.02	 Walnut	ATLANTIS Base with 2 hole	1
49003.02	 Oak		
49009.02	 White		
49011.02	 Raw		
49017.02	 Copper		



**Ceiling cup - Decorated
+ Wall plate round Edge Ø 80**

Ceiling lighting and suspension lighting with plate Ø 180 - Ø 280







CODE	FINISH	TYPE	PCS/PACK.
49002	 Walnut	WHITE ITALY	1
49004	 Oak		
49010	 White		
49012	 Raw		
49018	 Copper		
49002.01	 Walnut	ATLANTIS Base with 1 hole	1
49004.01	 Oak		
49010.01	 White		
49012.01	 Raw		
49018.01	 Copper		
49002.02	 Walnut	ATLANTIS Base with 2 hole	1
49004.02	 Oak		
49010.02	 White		
49012.02	 Raw		
49018.02	 Copper		



**Ceiling cup - Smooth
+ Wooden wall - Dimpled Edge Ø 100**

Ceiling lighting and suspension lighting with plate Ø 400
Abatjour - Applique







CODE	FINISH	TYPE	PCS/PACK.
49041	 Walnut	WHITE ITALY	1
49043	 Oak		
49049	 White		
49051	 Raw		
49057	 Copper		



**Ceiling cup - Smooth
+ Wooden wall - Round Edge Ø 100**

Ceiling lighting and suspension lighting with plate Ø 400
Abatjour - Applique







CODE	FINISH	TYPE	PCS/PACK.
49042	 Walnut	WHITE ITALY	1
49044	 Oak		
49050	 White		
49052	 Raw		
49058	 Copper		



**Ceiling cup - Decorated
+ Wall plate Dimpled Edge Ø 80**

Ceiling lighting and suspension lighting with plate
Ø 180 - Ø 280







CODE	FINISH	TYPE	PCS/PACK.
49005	 Walnut	WHITE ITALY	1
49007	 Oak		
49013	 White		
49015	 Raw		
49019	 Copper		



**Ceiling cup - Decorated
+ Wooden wall - Round Edge Ø 80**

Ceiling lighting and suspension lighting with plate
Ø 180 - Ø 280







CODE	FINISH	DATA	PCS/PACK.
49006	 Walnut	WHITE ITALY	1
49008	 Oak		
49014	 White		
49016	 Raw		
49020	 Copper		



**Ceiling cup - Decorated
+ Wooden wall - Dimpled Edge Ø 100**

Ceiling lighting and suspension lighting with plate Ø 400
Abatjour - Applique







CODE	FINISH	DATA	PCS/PACK.
49045	 Walnut	WHITE ITALY	1
49047	 Oak		
49053	 White		
49055	 Raw		
49059	 Copper		



**Ceiling cup - Decorated
+ Wooden wall - Round Edge Ø 100**





Ceiling lighting and suspension lighting with plate Ø 400
Abatjour - Applique



CODE	FINISH	DATA	PCS/PACK.
49046	 Walnut	WHITE ITALY	1
49048	 Oak		
49054	 White		
49056	 Raw		
49060	 Copper		







Ceiling cup for up down lighting
Dimpled Edge

CODE	FINISH	DATA	PCS/PACK.
49081	 Walnut	Combinable with Up and Down Lighting Page 66-67 TECHNICAL	1
49083	 Oak		
49085	 White		
49087	 Raw		
49089	 Copper		







Ceiling cup for up down lighting
Round Edge

CODE	FINISH	DATA	PCS/PACK.
49082	 Walnut	Combinable with Up and Down Lighting Page 66-67 TECHNICAL	1
49084	 Oak		
49086	 White		
49088	 Raw		
49090	 Copper		







Wall plate for applique with porcelain arm Ø 80
Dimpled Edge

CODE	FINISH	DATA	PCS/PACK.
49091	 Walnut	Combinable with Porcelain Arm Page 77-78 TECHNICAL	1
49093	 Oak		
49095	 White		
49097	 Raw		
49099	 Copper		



Wall plate for applique with porcelain arm Ø 80
Round Edge

CODE	FINISH	DATA	PCS/PACK.
49092	 Walnut	Combinable with Porcelain Arm Page 77-78 TECHNICAL	1
49094	 Oak		
49096	 White		
49098	 Raw		
49100	 Copper		



gi-loft

Our **simple but refined** Lighting GI-Loft collection is perfectly in line with the current trend of industrial vintage and modern minimal style.

Thanks to the endless **combination possibilities between colours and materials**, GI-Loft allows you to **customize** all the lamps, giving rise to a new style capable of communicating the essence of the people who live there.





→ preview





**My Wire
White Porcelain**

CODE

FINISH

DATA

PCS/PACK.

08A04



**My Wire S
White Porcelain**

Cable 3 x 0.75
MAX 60W | E27 | 50/60 Hz | 250V~
IP20 | €
For customization of length contact us



1

08A04X



**My Wire XL
White Porcelain**

Cable 3 x 0.75
MAX 60W | E27 | 50/60 Hz | 250V~
IP20 | €
For customization of length contact us

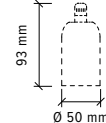
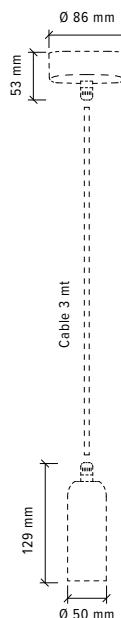

Silk Twisted Cable

	01	White
	02	Ivory
	03	Grey
	04	Brown
	05	Black
	06	Gold
	07	Bronze
	08	Autunno
	09	Tre Ori
	10	Dalia
	11	Catena
	12	Brazil
	13	Blue
	14	Red
	15	Dark Grey

Silk Round Cable

	20	White
	21	Ivory
	22	Grey
	23	Brown
	24	Black
	25	Gold
	26	Bronze
	27	Blue
	28	Red
	29	Dark Grey
	30	Red/Black
	31	White/Black
	32	Bronze/Black
	33	Green

Product Code

08A04X + 28 = 08A04X.28
es. My Wire XL es. Red Example of how to create your own product key

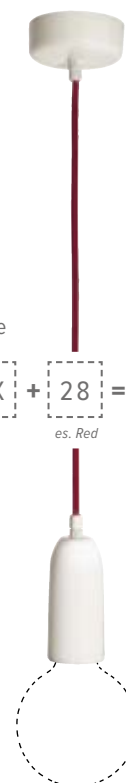





My Wire
Raw Charcoal - Grey Porcelain

CODE

FINISH

DATA

PCS/PACK.



08A07

My Wire S
Raw Charcoal Grey

Cable 3 x 0.75
MAX 60W | E27 | 50/60 Hz | 250V~
IP20 | €
For customization of length contact us

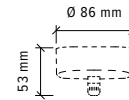

08A07X

My Wire XL
Raw Charcoal Grey

Cable 3 x 0.75
MAX 60W | E27 | 50/60 Hz | 250V~
IP20 | €
For customization of length contact us

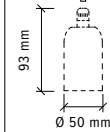
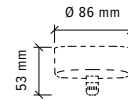

08A07C

My Wire Cilindro
Raw Charcoal Grey

Cable 3 x 0.75
MAX 60W | E27 | 50/60 Hz | 250V~
IP20 | €
For customization of length contact us

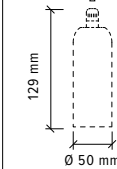
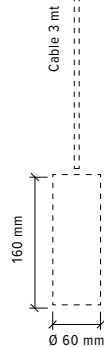
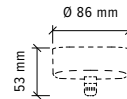



Silk Twisted Cable

	01	White
	02	Ivory
	03	Grey
	04	Brown
	05	Black
	06	Gold
	07	Bronze
	08	Autunno
	09	Tre Ori
	10	Dalia
	11	Catena
	12	Brazil
	13	Blue
	14	Red
	15	Dark Grey

Silk Round Cable

	20	White
	21	Ivory
	22	Grey
	23	Brown
	24	Black
	25	Gold
	26	Bronze
	27	Blue
	28	Red
	29	Dark Grey
	30	Red/Black
	31	White/Black
	32	Bronze/Black
	33	Green

Product Code

$$\boxed{08A07C} + \boxed{24} = \mathbf{08A07C.24}$$

es. My Wire Cilindro *es. Black* *Example of how to create your own product key*

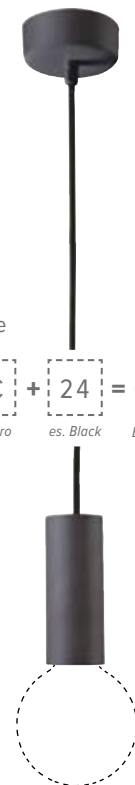



My Wire

CODE	FINISH	DATA	PCS/PACK.
08A01	Chrome	Cable 3 x 0,75 MAX 60W E27 50/60 Hz 250V~ IP20 € For customization of length contact us	1
08A03	Brushed Bronzed	Cable 3 x 0,75 MAX 60W E27 50/60 Hz 250V~ IP20 € For customization of length contact us	
08A06	Embossed Black	Cable 3 x 0,75 MAX 60W E27 50/60 Hz 250V~ IP20 € For customization of length contact us	

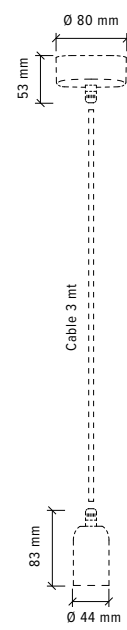

Silk Twisted Cable

	01	White
	02	Ivory
	03	Grey
	04	Brown
	05	Black
	06	Gold
	07	Bronze
	08	Autunno
	09	Tre Ori
	10	Dalia
	11	Catena
	12	Brazil
	13	Blue
	14	Red
	15	Dark Grey

Silk Round Cable

	20	White
	21	Ivory
	22	Grey
	23	Brown
	24	Black
	25	Gold
	26	Bronze
	27	Blue
	28	Red
	29	Dark Grey
	30	Red/Black
	31	White/Black
	32	Bronze/Black
	33	Green

Product Code

08A03 + 24 = **08A03.24**
es. My Wire *es. Black* *Example of how to create your own product key*
Brushed Bronzed

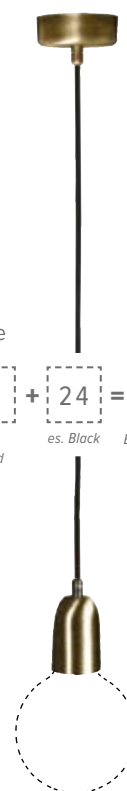





My Cup

CODE

FINISH

DATA

PCS/PACK.

08C01



Brushed Chrome

Cable 3 x 0.75
 MAX 60W | E27 | 50/60 Hz | 250V~
 IP20 | €
 For customization of length contact us

08C02



Antique Brass

Cable 3 x 0.75
 MAX 60W | E27 | 50/60 Hz | 250V~
 IP20 | €
 For customization of length contact us

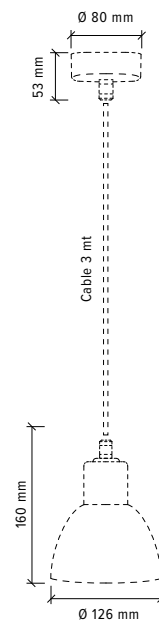

1

Silk Twisted Cable

	01	White
	02	Ivory
	03	Grey
	04	Brown
	05	Black
	06	Gold
	07	Bronze
	08	Autunno
	09	Tre Ori
	10	Dalia
	11	Catena
	12	Brazil
	13	Blue
	14	Red
	15	Dark Grey

Silk Round Cable

	20	White
	21	Ivory
	22	Grey
	23	Brown
	24	Black
	25	Gold
	26	Bronze
	27	Blue
	28	Red
	29	Dark Grey
	30	Red/Black
	31	White/Black
	32	Bronze/Black
	33	Green

Product Code



08C01 + 13 = 08C01.13
 es. My Cup es. Black Example of how to create your own product key
 Brushed Chrome







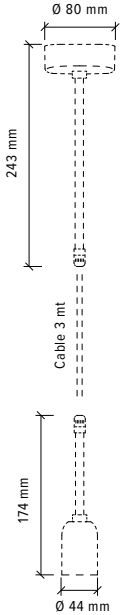









My Stick'n'Wire













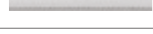

CODE FINISH DATA PCS/PACK.

<p>08B01</p> 	<p>Brushed Chrome</p>	<p>Cable 3 x 0.75 MAX 60W E27 50/60 Hz 250V~ IP20 €€ For customization of length contact us</p>		<p>1</p>
<p>08B03</p> 	<p>Brushed Bronzed</p>	<p>Cable 3 x 0.75 MAX 60W E27 50/60 Hz 250V~ IP20 €€ For customization of length contact us</p>		
<p>08B06</p> 	<p>Embossed Black</p>	<p>Cable 3 x 0.75 MAX 60W E27 50/60 Hz 250V~ IP20 €€ For customization of length contact us</p>		

Silk Twisted Cable

	01	White
	02	Ivory
	03	Grey
	04	Brown
	05	Black
	06	Gold
	07	Bronze
	08	Autunno
	09	Tre Ori
	10	Dalia
	11	Catena
	12	Brazil
	13	Blue
	14	Red
	15	Dark Grey

Silk Round Cable

	20	White
	21	Ivory
	22	Grey
	23	Brown
	24	Black
	25	Gold
	26	Bronze
	27	Blue
	28	Red
	29	Dark Grey
	30	Red/Black
	31	White/Black
	32	Bronze/Black
	33	Green

Product Code

08B01 + 27 = **08B01.27**

es. My Stick'n'Wire
Brushed Chrome

es. Blue

Example of how to create
your own product key





My Wall Stick
Raw Charcoal - Grey Porcelain

CODE

FINISH

DATA

PCS/PACK.

08J01C  **Brashed Chrome**

08J03C  **Brashed Bronzed**





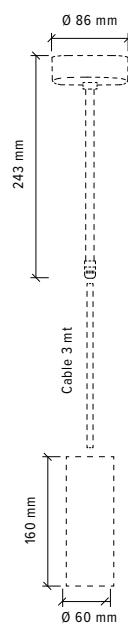









08J06C  **Embossed Black**

Cable 3 x 0.75
MAX 60W E27 50/60 Hz 250V~
IP20 €€
For customization of length contact us
Cable 3 x 0.75
MAX 60W E27 50/60 Hz 250V~
IP20 €€
For customization of length contact us
Cable 3 x 0.75
MAX 60W E27 50/60 Hz 250V~
IP20 €€
For customization of length contact us













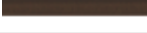
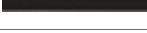

1

Silk Twisted Cable

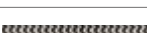
	01	White
	02	Ivory
	03	Grey
	04	Brown
	05	Black
	06	Gold
	07	Bronze
	08	Autunno
	09	Tre Ori
	10	Dalia
	11	Catena
	12	Brazil
	13	Blue
	14	Red
	15	Dark Grey

Silk Round Cable

	20	White
	21	Ivory
	22	Grey
	23	Brown
	24	Black
	25	Gold
	26	Bronze
	27	Blue
	28	Red
	29	Dark Grey
	30	Red/Black
	31	White/Black
	32	Bronze/Black
	33	Green

Product Code

08J01C + 27 = **08J01C.27**
 es. My Wall Stick Brashed Chrome es. Blue Example of how to create your own product key





My Essential

CODE	FINISH	DATA	PCS/PACK.
08K0A.00	Porcellana & Gold	MAX 60W E27 50/60 Hz 250V~ IP20 €	1
08K01.00	Porcellana & Chrome	MAX 60W E27 50/60 Hz 250V~ IP20 €	
08K09.00	Porcellana & Copper	MAX 60W E27 50/60 Hz 250V~ IP20 €	

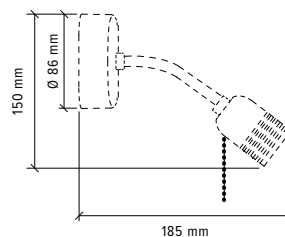



My Flex

CODE

FINISH

DATA

PCS/PACK

08E01.40

Chrome
+ Dark Grey/Black
Flexible Tube Silk
Covered

08E03.41

Brushed Bronze
+ Bronze/Black
Flexible Tube Silk
Covered

08E06.40

Black
+ Dark Grey/Black
Flexible Tube Silk
Covered

08E06.41

Black
+ Bronze/Black
Flexible Tube Silk
Covered

08E01.00

Nichel

MAX 60W | E27 | 50/60 Hz | 250V~

IP20 | €€

For customization of length contact us

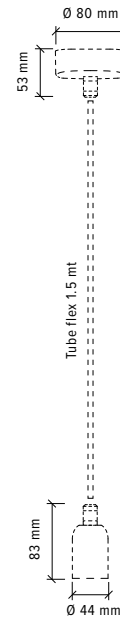

1





My Tube

CODE

FINISH

DATA

PCS/PACK.

08F05.00



Cor-ten

08F06.00



Black

Tube 805 mm
 MAX 60W | E27 | 50/60 Hz | 250V~
 IP20 | CE

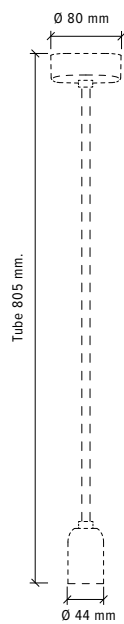

1



My Sticks

CODE

FINISH

DATA

PCS/PACK.

08G01.00



Chrome

08G03.00



Brushed Bronzed

Tube 805 mm
 MAX 60W | E27 | 50/60 Hz | 250V~
 IP20 | CE

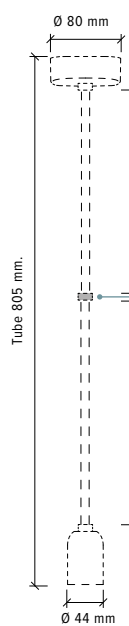

Prodotto fornito già assemblato



giunzione

1

If you want to increase the length, you can order 35 cm sticks in addition.





**My Multiple
White Porcelain**

CODE	FINISH	SUSPENSIONS	CABLE	CABLE CLAMPS	DATA	PCS/PACK.
08M24.XA		S	2	5 mt		
08M34.XA		S	3	7 mt		
08M44.XA		S	4	10 mt		
08M54.XA		S	5	12 mt		
08M64.XA		S	6	15 mt		
08M74.XA		S	7	17 mt		
08M84.XA		S	8	20 mt		
08M94.XA		S	9	22 mt		
08MA4.XA		S	10	25 mt		
08M24X.XA		XL	2	5 mt		
08M34X.XA		XL	3	7 mt		
08M44X.XA		XL	4	10 mt		
08M54X.XA		XL	5	12 mt		
08M64X.XA		XL	6	15 mt		
08M74X.XA		XL	7	17 mt		
08M84X.XA		XL	8	20 mt		
08M94X.XA		XL	9	22 mt		
08MA4X.XA		XL	10	25 mt		
08M24M.XA	(1) (1)	Mix	2	5 mt		
08M34M.XA	(2) (1)	Mix	3	7 mt		
08M44M.XA	(2) (2)	Mix	4	10 mt		
08M54M.XA	(2) (3)	Mix	5	12 mt		
08M64M.XA	(3) (3)	Mix	6	15 mt		
08M74M.XA	(4) (3)	Mix	7	17 mt		
08M84M.XA	(4) (4)	Mix	8	20 mt		
08M94M.XA	(4) (5)	Mix	9	22 mt		
08MA4M.XA	(5) (5)	Mix	10	25 mt		

Cable 3 x 0.75
 MAX 60W | E27 | 50/60 Hz | 250V~
 CEILING **2-6 Sosp.** Ø 86 mm | **7-10 Sosp.** Ø 120 mm
 IP20 | CE

For customization of length contact us
 Product supplied disassembled in assembly kit to customize the installation.

1





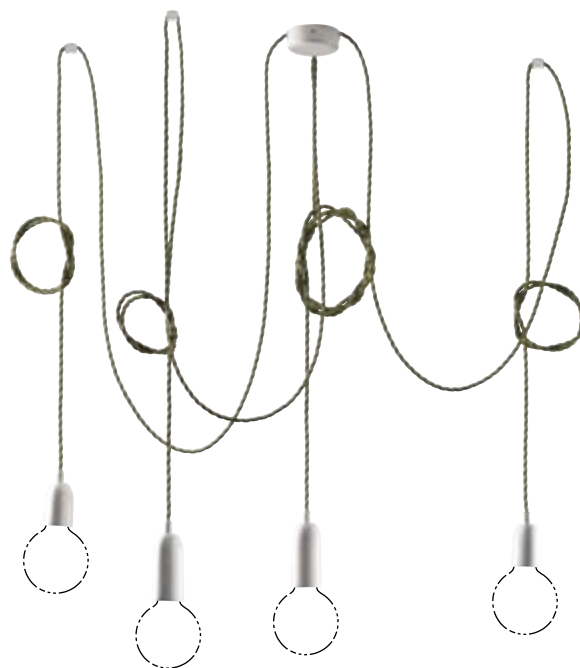









Product Code

08M44M.XA and 710732 = 08M44M.XA and 710732
 es. MY Multiple Mix 4 suspensions es. Brazil Example of how to request your composite Product Code composito















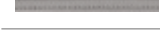

Silk Twisted Cable

-  **710007** White
-  **710107** Ivory
-  **710207** Grey
-  **710307** Brown
-  **710407** Black
-  **710507** Gold
-  **710607** Bronze
-  **710728** Autunno
-  **710729** Tre Ori
-  **710730** Dalia
-  **710731** Catena
-  **710732** Brazil
-  **710733** Blue
-  **710734** Red
-  **710735** Dark Grey

Silk Round Cable

-  **710718** White
-  **710719** Ivory
-  **710716** Grey
-  **710720** Brown
-  **710721** Black
-  **710715** Gold
-  **710717** Bronze
-  **710722** Blue
-  **710723** Red
-  **710724** Dark Grey
-  **710725** Red/Black
-  **710726** White/Black
-  **710727** Bronze/Black
-  **710736** Green



Charcoal Grey Porcelain
Raw

CODE	FINISH	SUSPENSIONS	CABLE	CABLE CLAMPS	DATA	PCS/PACK.
08M27.XE		S	2	5 mt	2	
08M37.XE		S	3	7 mt	3	
08M47.XE		S	4	10 mt	4	
08M57.XE		S	5	12 mt	5	
08M67.XE		S	6	15 mt	6	
08M77.XE		S	7	17 mt	7	
08M87.XE		S	8	20 mt	8	
08M97.XE		S	9	22 mt	9	
08MA7.XE		S	10	25 mt	10	
08M27X.XE		XL	2	5 mt	2	
08M37X.XE		XL	3	7 mt	3	
08M47X.XE		XL	4	10 mt	4	
08M57X.XE		XL	5	12 mt	5	
08M67X.XE		XL	6	15 mt	6	
08M77X.XE		XL	7	17 mt	7	
08M87X.XE		XL	8	20 mt	8	
08M97X.XE		XL	9	22 mt	9	
08MA7X.XE		XL	10	25 mt	10	
08M27M.XE	(1) (1)	Mix	2	5 mt	2	
08M37M.XE	(2) (1)	Mix	3	7 mt	3	
08M47M.XE	(2) (2)	Mix	4	10 mt	4	
08M57M.XE	(2) (3)	Mix	5	12 mt	5	
08M67M.XE	(3) (3)	Mix	6	15 mt	6	
08M77M.XE	(4) (3)	Mix	7	17 mt	7	
08M87M.XE	(4) (4)	Mix	8	20 mt	8	
08M97M.XE	(4) (5)	Mix	9	22 mt	9	
08MA7M.XE	(5) (5)	Mix	10	25 mt	10	
08M27C.XE		Cilindro	2	5 mt	2	
08M37C.XE		Cilindro	3	7 mt	3	
08M47C.XE		Cilindro	4	10 mt	4	
08M57C.XE		Cilindro	5	12 mt	5	
08M67C.XE		Cilindro	6	15 mt	6	
08M77C.XE		Cilindro	7	17 mt	7	
08M87C.XE		Cilindro	8	20 mt	8	
08M97C.XE		Cilindro	9	22 mt	9	
08MA7C.XE		Cilindro	10	25 mt	10	

Cable 3 x 0.75
 MAX 60W | E27 | 50/60 Hz | 250V~
 CEILING 2-6 Sosp. Ø 86 mm | 7-10 Sosp. Ø 120 mm
 IP20 | CE
 For customization of length contact us

Product supplied disassembled in assembly kit to customize the installation.















Product Code

08M67X.XE and 710726 = 08M67X.XE and 710726
 es. My Multiple XL 6 SUSPENSIONS es. White/Black Example of how to request your composite Product Code composito



















Silk Twisted Cable

-  **710007** White
-  **710107** Ivory
-  **710207** Grey
-  **710307** Brown
-  **710407** Black
-  **710507** Gold
-  **710607** Bronze
-  **710728** Autunno
-  **710729** Tre Ori
-  **710730** Dalia
-  **710731** Catena
-  **710732** Brazil
-  **710733** Blue
-  **710734** Red
-  **710735** Dark Grey

Silk Round Cable

-  **710718** White
-  **710719** Ivory
-  **710716** Grey
-  **710720** Brown
-  **710721** Black
-  **710715** Gold
-  **710717** Bronze
-  **710722** Blue
-  **710723** Red
-  **710724** Dark Grey
-  **710725** Red/Black
-  **710726** White/Black
-  **710727** Bronze/Black
-  **710736** Green



My Multiple

CODE	FINISH	SUSPENSIONS	CABLE	CABLE CLAMPS	DATA	PCS/PACK.
08M21.XC	Chrome	2	5 mt	1		
08M31.XC	Chrome	3	7 mt	2		
08M41.XC	Chrome	4	10 mt	3		
08M51.XC	Chrome	5	12 mt	4		
08M61.XC	Chrome	6	15 mt	5		
08M71.XC	Chrome	7	17 mt	6		
08M81.XC	Chrome	8	20 mt	7		
08M91.XC	Chrome	9	22 mt	8		
08MA1.XC	Chrome	10	25 mt	9		
08MB1.XC	Chrome	11	27 mt	10		
08MC1.XC	Chrome	12	30 mt	11		
08M23.XF	Burnished	2	5 mt	1		
08M33.XF	Burnished	3	7 mt	2		
08M43.XF	Burnished	4	10 mt	3		
08M53.XF	Burnished	5	12 mt	4		
08M63.XF	Burnished	6	15 mt	5		
08M73.XF	Burnished	7	17 mt	6		
08M83.XF	Burnished	8	20 mt	7		
08M93.XF	Burnished	9	22 mt	8		
08MA3.XF	Burnished	10	25 mt	9		
08MB3.XF	Burnished	11	27 mt	10		
08MC3.XF	Burnished	12	30 mt	11		
08M26.XE	Black	2	5 mt	1		
08M36.XE	Black	3	7 mt	2		
08M46.XE	Black	4	10 mt	3		
08M56.XE	Black	5	12 mt	4		
08M66.XE	Black	6	15 mt	5		
08M76.XE	Black	7	17 mt	6		
08M86.XE	Black	8	20 mt	7		
08M96.XE	Black	9	22 mt	8		
08MA6.XE	Black	10	25 mt	9		
08MB6.XE	Black	11	27 mt	10		
08MC6.XE	Black	12	30 mt	11		

Cable 3 x 0.75
 MAX 60W | E27 | 50/60 Hz | 250V~
 CEILING 2-6 Sosp. Ø 86 mm | 6-12 Sosp. Ø 150 mm
 IP20 | CE
 For customization of length contact us
 Product supplied disassembled in assembly kit to customize the installation.

1





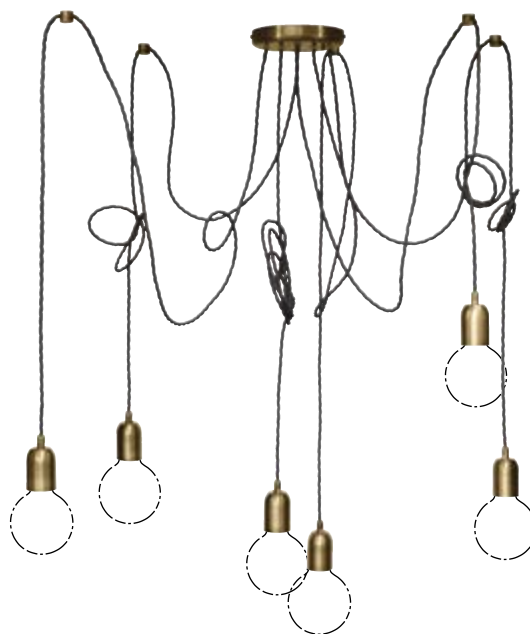

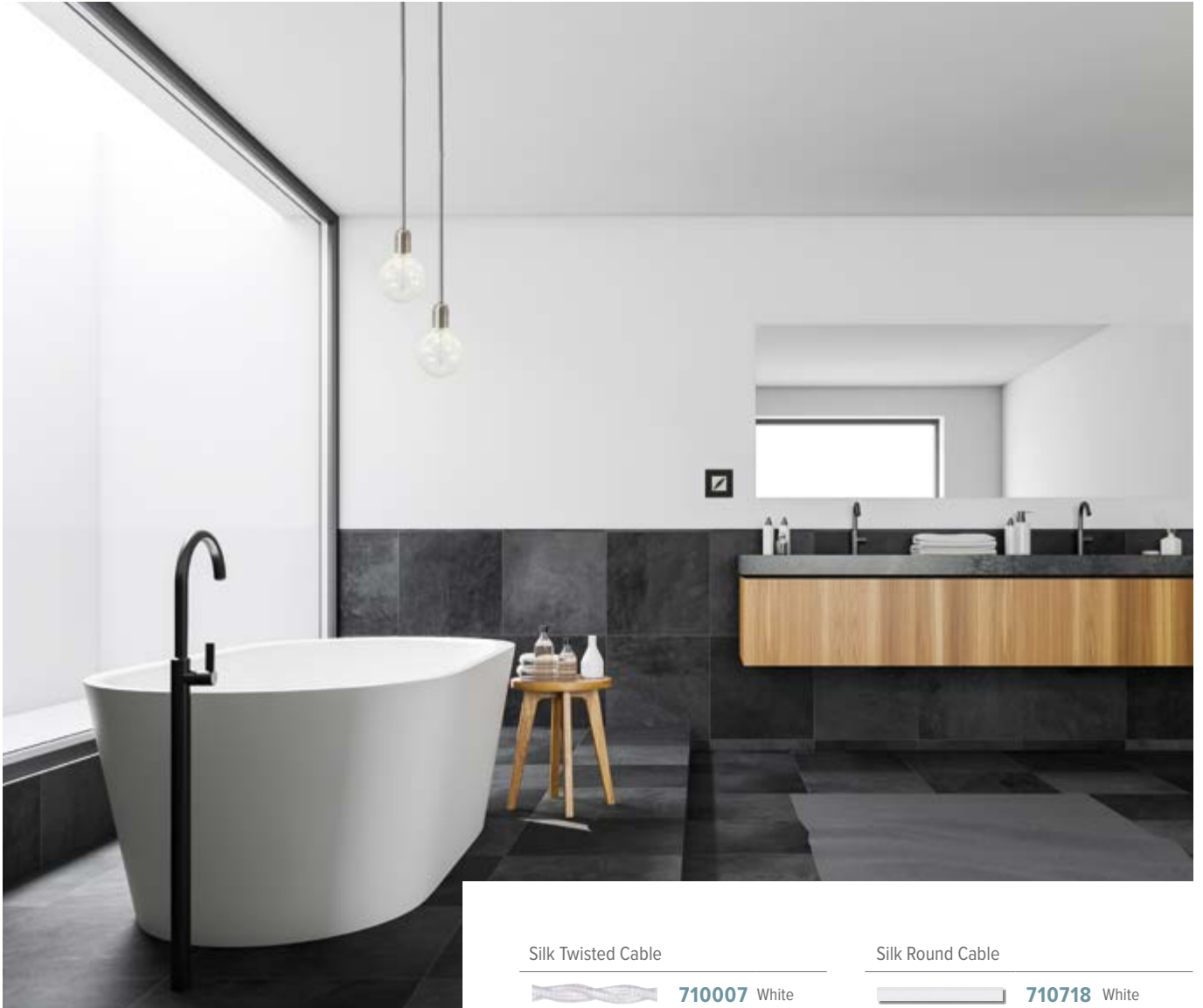







Product Code

08M63.XF and 710407 = 08M63.XF and 710407
 es. My Multiple Burnished 6 SUSPENSIONS es. Black Example of how to request your composite Product Code composto



















Silk Twisted Cable

	710007 White
	710107 Ivory
	710207 Grey
	710307 Brown
	710407 Black
	710507 Gold
	710607 Bronze
	710728 Autunno
	710729 Tre Ori
	710730 Dalia
	710731 Catena
	710732 Brazil
	710733 Blue
	710734 Red
	710735 Dark Grey

Silk Round Cable

	710718 White
	710719 Ivory
	710716 Grey
	710720 Brown
	710721 Black
	710715 Gold
	710717 Bronze
	710722 Blue
	710723 Red
	710724 Dark Grey
	710725 Red/Black
	710726 White/Black
	710727 Bronze/Black
	710736 Green



My Wire GU10
Charcoal Grey Porcelain - Rough

CODE

FINISH

DATA

PCS/PACK.

08A07CG

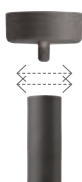

Cylinder

Cable 3 x 0.75
MAX 60W | GU10 | 50/60 Hz | 250V~
IP20 | CE
For customization of length contact us

Product supplied disassembled
in assembly kit to customize
the installation.

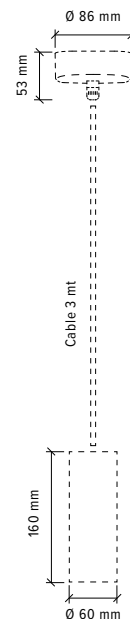

1

Silk Twisted Cable

	01	White
	02	Ivory
	03	Grey
	04	Brown
	05	Black
	06	Gold
	07	Bronze
	08	Autunno
	09	Tre Ori
	10	Dalia
	11	Catena
	12	Brazil
	13	Blue
	14	Red
	15	Dark Grey

Silk Round Cable

	20	White
	21	Ivory
	22	Grey
	23	Brown
	24	Black
	25	Gold
	26	Bronze
	27	Blue
	28	Red
	29	Dark Grey
	30	Red/Black
	31	White/Black
	32	Bronze/Black
	33	Green

Product Code

08A07CG
+
28
=
08A07CG.28

es. My Wire GU10 es. Red Example of how to create your own product key





My Wall Stick GU10
Raw Charcoal - Grey Porcelain

CODE FINISH DATA PCS/PACK.

08J01CG		Chrome
08J03CG		Brushed Bronze
08J06CG		Embossed Black

Cable 3 x 0.75
MAX 60W | GU10 | E27
50/60 Hz | 250V~
IP20 | CE
For customization of length contact us

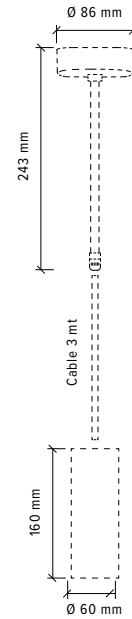

1

Silk Twisted Cable

	01	White
	02	Ivory
	03	Grey
	04	Brown
	05	Black
	06	Gold
	07	Bronze
	08	Autunno
	09	Tre Ori
	10	Dalia
	11	Catena
	12	Brazil
	13	Blue
	14	Red
	15	Dark Grey

Silk Round Cable

	20	White
	21	Ivory
	22	Grey
	23	Brown
	24	Black
	25	Gold
	26	Bronze
	27	Blue
	28	Red
	29	Dark Grey
	30	Red/Black
	31	White/Black
	32	Bronze/Black
	33	Green

Product Code

08J01CG + 26 = 08J01CG.26

es. My Wall Stick GU10

es. Bronze

Example of how to create your own product key





My Multiple GU10

CODE	SUSPENSIONS	CABLE	CABLE CLAMPS	DATA	PCS/PACK
08M27CG.XE	2	5 mt	2	Cable 3 x 0.75 MAX 60W GU10 50/60 Hz 250V~ IP20 CE For customization of length contact us Product supplied disassembled in assembly kit to customize the installation.	1
08M37CG.XE	3	7 mt	3		
08M47CG.XE	4	10 mt	4		
08M57CG.XE	5	12 mt	5		
08M67CG.XE	6	15 mt	6		
08M77CG.XE	7	17 mt	7		
08M87CG.XE	8	20 mt	8		
08M97CG.XE	9	22 mt	9		
08MA7CG.XE	10	25 mt	10		

Product Code

08M37CG.XE and 710722 = **08M37CG.XE**
es. My Multiple GU10 3 SUSPENSIONS es. Blue and = **710722**
Example of how to create your own product key

Silk Twisted Cable

- 710007** White
- 710107** Ivory
- 710207** Grey
- 710307** Brown
- 710407** Black
- 710507** Gold
- 710607** Bronze
- 710728** Autunno
- 710729** Tre Ori
- 710730** Dalia
- 710731** Catena
- 710732** Brazil
- 710733** Blue
- 710734** Red
- 710735** Dark Grey

Silk Round Cable

- 710718** White
- 710719** Ivory
- 710716** Grey
- 710720** Brown
- 710721** Black
- 710715** Gold
- 710717** Bronze
- 710722** Blue
- 710723** Red
- 710724** Dark Grey
- 710725** Red/Black
- 710726** White/Black
- 710727** Bronze/Black
- 710736** Green

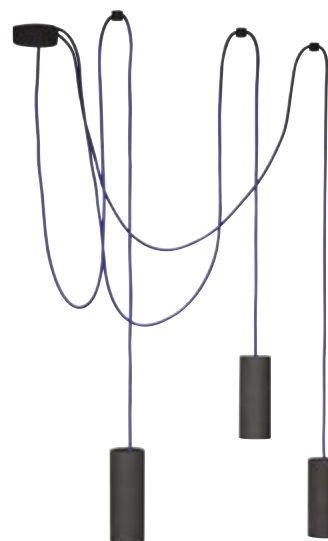







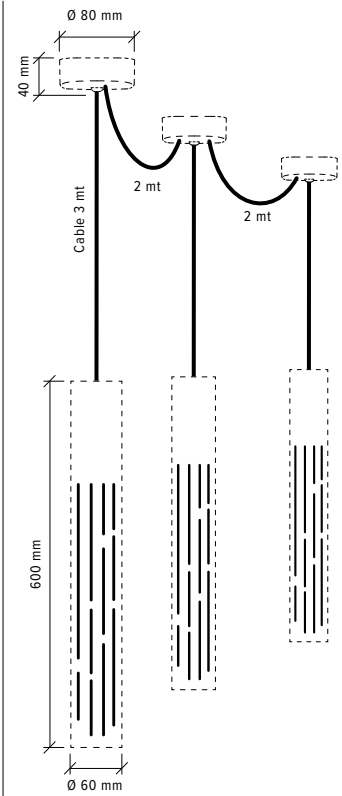









Riace















CODE	SUSPENSIONS	DATA	PCS/PACK
08H08.01	Mat Raw Iron 1	Cable 3 x 0.75 MAX 60W GU10 50/60 Hz 250V~ IP20 CE For customization of length contact us Product supplied disassembled in assembly kit to customize the installation.	1
08H08.02	Mat Raw Iron 2		
08H08.03	Mat Raw Iron 3		
08H08.04	Mat Raw Iron 4		
08H08.05	Mat Raw Iron 5		
08H08.06	Mat Raw Iron 6		
08H06.01	Black Semi-Polish 1		
08H06.02	Black Semi-Polish 2		
08H06.03	Black Semi-Polish 3		
08H06.04	Black Semi-Polish 4		
08H06.05	Black Semi-Polish 5		
08H06.06	Black Semi-Polish 6		



Silk Twisted Cable

-  **710007** White
-  **710107** Ivory
-  **710207** Grey
-  **710307** Brown
-  **710407** Black
-  **710507** Gold
-  **710607** Bronze
-  **710728** Autunno
-  **710729** Tre Ori
-  **710730** Dalia
-  **710731** Catena
-  **710732** Brazil
-  **710733** Blue
-  **710734** Red
-  **710735** Dark Grey

Silk Round Cable

-  **710718** White
-  **710719** Ivory
-  **710716** Grey
-  **710720** Brown
-  **710721** Black
-  **710715** Gold
-  **710717** Bronze
-  **710722** Blue
-  **710723** Red
-  **710724** Dark Grey
-  **710725** Red/Black
-  **710726** White/Black
-  **710727** Bronze/Black
-  **710736** Green



Product Code









Decorative bulbs Filament E27

CODE	FINISH	DATA	PCS/PACK.
660060.01	 Smoked	\varnothing 125 mm <hr/> 40W 230V~ 60 lm E (40KWh/1000h)	1
660060.02	 Trasparent	<hr/> IP20 €	



Decorative Bulbs Soft LED E27

CODE	FINISH	DATA	PCS/PACK.
660060.03	 Smoked	\varnothing 125 mm <hr/> 5W 230V 280lm A (50KWh/1000h)	1
660060.04	 Trasparent	<hr/> IP20 €	



SPARE PARTS



**Fusion
Base Ø 105**

CODE	SPARE PARTS	DATA	PCS/PACK.
631001	Junction Box (See art.31.510.00)	 Ø 105 h 39 mm foro per Tube Ø 20 IP20	1



**Fusion
Base Ø 88**

CODE	SPARE PARTS	DATA	PCS/PACK.
631002	UNEL Socket-outlet (See art.31.210.00)	 Ø 88 h 37 mm foro per Tube Ø 16 IP20	1
631003	German and French Schuko socket-outlet (See art.31.255.00. 31.254.00)		



**Fusion
Base Ø 80**

CODE	SPARE PARTS	DATA	PCS/PACK.
631004	Universal	 Ø 80 h 30 mm foro per Tube Ø 16 IP20	1



Porcelain Plate
Godet



CODE	TYPE	PCS/PACK.
08001	Ø 180	1
08011	Ø 280	



Porcelain Plate
Godet Filo Oro



CODE	TYPE	PCS/PACK.
08031	Ø 180	1
08041	Ø 280	



Porcelain Plate
Ventaglio



CODE	TYPE	PCS/PACK.
08101	Ø 180	1
08111	Ø 280	
08151	Ø 400	



Porcelain Plate
Ventaglio Gocce Oro



CODE	TYPE	PCS/PACK.
08131	Ø 180	1
08141	Ø 280	
08161	Ø 400	



**Porcelain Plate
Antique Gocce Oro**



CODE

TYPE

PCS/PACK.

08163

Ø 400

1



Glasses

CODE

FINISH

PCS/PACK.

08201

**Mimosa**

08221

**Iris**

08231

**Girasole**

08280

**Wall Lamp**

1



CODE

Pulley for Up Down Lamp

PCS/PACK.

08310

Ceiling cup with pulley

1



CODE

Counterweight for Up Down Lamp

PCS/PACK.

08311

Ceiling cup with pulley

1

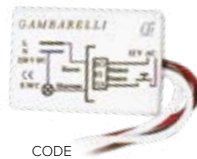

CODE

Step Relay

PCS/PACK.

01702

12V | 8A

1



CODE

Button Interface

PCS/PACK.

01704

100-260V

1



CODE

Toroidal Transformer



PCS/PACK.

01711

PRI 230VAC - SEC 12VAC

1





Exhibition sample panels

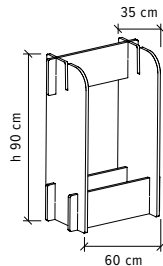

920027
Base for sample panels
50 x 110 cm

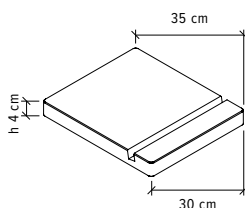

920528
Base for sample panels
30 x 60 cm



920720
Dark Cement
Sample Panel without Base
50 cm | h 110 cm



920721
Light Cement
Sample Panel without Base
50 cm | h 110 cm



920722
Dark Cement
Sample Panel without Base
30 cm | h 60 cm



920723
Light Cement
Sample Panel without Base
30 cm | h 60 cm

PRODUCT CERTIFICATION AND REGULATIONS

SWITCHES REFERENCE STANDARDS

European directive

2014/35/UE

Low-voltage directive

CEI 23-9 2004/108/CE

Direttiva Compatibilità Elettromagnetica in riferimento alla norma di prodotto:

CEI 23-9 EN 60669-1 (2018-07) + EC (2019-2023)

Electromagnetic compatibility directive according to the product rule:

Part 1: General requirements

VDE 0632 teli 1:2019-03

Switches for household and similar fixed-electrical installations

ELECTRICAL SOCKETS REFERENCE STANDARDS

CEI 23-50 (2007) + V1 (2008) + V2 (2011) + V3 (2015) + V4 (2015)

Plugs and sockets for household and similar fixed-electrical installations

Parte 1: Prescrizioni generali

IEC 60884 (2022)

Spine e prese per usi domestici e similari

Part 1: General requirements **DIN VDE 0620-1 (2021-02)**

Plugs and sockets for household and similar fixed-electrical installations

Parte 1: General requirements on fixed socket-outlets

DIN 49440-1 (2006)

Two pole socket-outlets with earthing contact

Parte 1: SIZES principali

NORMATIVA DI RIFERIMENTO PER PRESE TV

CEI EN 61386-1 (2009-04) + A1 (2020-02)

CEI 23-81

Cable networks for television signals, sound signals and interactive services

Part 2: Main dimension

NORMATIVA DI RIFERIMENTO PER PRESE TELEFONICHE E DATA

CEI EN 61386-21 (2022-09)

CEI 23-80;V1

Information technology equipment - Radio disturbance characteristics -

Limits and methods of measurement

TWISTED CABLE REFERENCE STANDARDS

European directive

2006/95/CE

Low-voltage directive

HD 21.3 S3:1995 + A1:1999

Polyvinyl chloride insulated cables of rated voltages up to 450/750 V

CEI EN 60332-1-2 e CPR

Tests on electric and optical cables in case of fire

NORMATIVA DI RIFERIMENTO PER SISTEMI DI TUBI

CEI EN 61386-1 (2009-04) + A1 (2020-02)

CEI 23-81

Conduit systems for cable management

Parte 1: General requirements

CEI EN 61386-21 (2022-09)

CEI 23-80;V1

Conduit systems for cable management

Part 21: Particular requirements - Rigid conduit systems



GENERAL SALES CONDITIONS

1. ASSUMPTION OF THE CONTRACT

Every order is accepted and every supply is carried out according to the General Sales Conditions indicated below; therefore the placing of an order or an offer, made in any form, is valid as express and complete acceptance of these General Sales Conditions without reservation of any kind, unless the exceptions or further conditions have been prepared or confirmed in writing by GI GAMBARELLI. The purchase order is valid as a fixed-term contractual proposal, binding on the offerer for a period of three months, from the moment of its knowledge by GI GAMBARELLI which reserves the right to accept it or not, within the period indicated above. These General Sales Conditions are valid exclusively for direct contracts between GI GAMBARELLI and professional operators. On this point, buyers declare that they are acting for professional purposes and that they are in no way final consumers.

2. RISKS

The goods, even if free at destination, always travel at the buyer's own risk. Upon receipt of the goods, the latter must in his/her own interest verify the quantity and conditions before collection and, if necessary, make the appropriate reservations immediately and in writing to the carrier. Any dispute relating to the number and condition of the packages delivered will be rejected when the buyer has not expressed such disputes in writing to both the carrier and GI GAMBARELLI no later than two days from receipt of the goods.

3. DELIVERY

The goods are delivered ex GI GAMBARELLI works. GI GAMBARELLI reserves in any case the right to ship the goods, within Italian territory, carriage paid for orders with a value exceeding Euro 800.00. For orders of a lower value and for all orders with foreign destinations, transport costs are charged on the invoice. The delivery terms are purely indicative and are always given without guarantee and except in cases of force majeure or unforeseen events not attributable to fraud or gross negligence on the part of GI GAMBARELLI. In no case of delay or partial fulfillment of product deliveries, the buyer will have the right to refuse the risk, even partial, of the goods shipped. The buyer renounces any compensation or claim for compensation against GI GAMBARELLI for direct and indirect damages due to delays or partial fulfillment of deliveries.

4. QUANTITY - PACKAGING

The orders must comply with the minimum packaging quantities. In case of orders with smaller quantities, GI GAMBARELLI reserves the right to round up to the standard packaging quantities, up-on communication to the buyer. Unless otherwise expressly agreed, packaging is invoiced at cost.

5. PRICES (VAT NOT INCLUDED)

GI GAMBARELLI prices are for goods returned free ex-works our factory. They are simply indicative in nature and do not bind GI GAMBARELLI in any way, which reserves the right to make changes to them appropriate to the increases in manpower, raw materials and other cost elements that may have occurred during the contractual relationship and up to the day of shipment and, in any case, to modify the price list during the year.

6. TECHNICAL SPECIFICATIONS AND PRODUCT MODIFICATIONS

All GI GAMBARELLI products are built to perfection. In terms of safety, if installed correctly by expert personnel, used in accordance with the use for which they are intended, subjected to suitable and adequate maintenance by qualified personnel, they safeguard the safety of people, animals and things. GI GAMBARELLI, within the framework of legislation, reserves the right to make (at any time and without prior notice) all modifications which, at its sole discretion, it deems appropriate to improve the functionality and performance of the products, as well as to respond to your technological and production needs. The indications, measurements, drawings and photos of the products and components are provided for information purposes and have no binding nature as they can be modified without notice. All products must be connected and installed according to the "System" regulations in force in the countries of destination and the information contained in the Catalog and on any instruction sheets or manuals by trained personnel.

7. WARRANTIES, CLAIMS AND LIABILITY

Any complaint due to failure or manufacturing defects and/or quality defects of the goods must be submitted to GI GAMBARELLI in writing under penalty of forfeiture within 8 (eight) days of receipt of the products in the event of apparent defects and/or faults and within 8 (eight) days of discovery in the event of hidden defects and/or faults. For the admissibility of the complaint, the purchaser must demonstrate correct storage and, if the product has already been installed, also correct installation. The warranty provided is limited, at the exclusive choice of GI GAMBARELLI, to the replacement of defective parts or products (either with identical or similar products) or through the repair of defective parts/products. In any case, compensation for any damage and reimbursement of any expense deriving from the use of products, their repairs or replacements as well as, for Example, the blocking of the systems in which the materials are intended to operate are excluded. Therefore, GI GAMBARELLI is exempt, subject to mandatory legal limits, from any contractual or non-contractual liability. GI GAMBARELLI does not assume any responsibility for products marketed and/or installed in countries where there are regulations that do not allow their use or for uses for which they are not intended, the responsibility for which remains with the purchaser and/or user.

8. RETURNS

The return of the goods is not permitted without written authorization from GI GAMBARELLI, failing which the goods will be returned to the sender with transport costs charged. In the event of an authorized return, the goods must be returned free at destination to the GI GAMBARELLI warehouses within the essential period of 8 days, starting from the date of receipt of the authorization from GI GAMBARELLI, and will be credited at the purchase price and burdened with a charge as compensation for administrative costs in the minimum conventional amount of 15% (fifteen percent). GI GAMBARELLI reserves the right, however, not to accept the return, or to apply a higher percentage as compensation for administrative costs in the case of goods returned after the deadline indicated above.

9. PAYMENTS

The goods are sold with express agreement of retention of title in favour of GI GAMBARELLI until the price is paid in full: only at this point the ownership of the purchased products will pass to the buyer. Payments may be made in compliance with the methods indicated in the supply conditions in force. Delay in payment, even partial, of invoices beyond their due date gives rise to the immediate start of interest entitlement, in compliance with the provisions of the Italian Legislative Decree 231/02 (implementing Directive 2000/35 EC) regarding delays in payment in commercial transactions. Failure to pay for any reason authorizes GI GAMBARELLI to suspend further supplies. The suspension of supplies is also foreseen in the event that a significant change occurs in the economic situation of the buyer such as, by way of Example and not limited to, receivership, composition with creditors, bankruptcy, cessation of business or in any case serious financial difficulty. For payments by receipt or bank transfer or other forms of payment, any collection and stamp duty costs are at the buyer's expense. The conditional discount within agreed terms when provided for by the contract or agreements is subject to strict compliance with the payment terms; beyond these terms it loses its validity and the buyer who has unduly retained it has the obligation to reimburse it. The buyer cannot raise any objection with the sole exception of invalidations, cancellations and terminations of the contract within the terms of the law. Failure to pay within the agreed terms will result in the buyer losing the benefit of the discount.

10. APPLICABLE LAW AND PLACE OF JURISDICTION

The contracts, even if stipulated with foreign buyers and for materials supplied abroad, are governed by Italian legislation. The place of jurisdiction for any dispute is exclusively that of Reggio Emilia.

11. PRIVACY

GI GAMBARELLI undertakes to collect and process the personal data of which it becomes aware in compliance with the Italian Legislative Decree 196/03. with the purposes connected to the execution of this contract and for the fulfillment of any legal obligation including fiscal or accounting nature.



REPRESENTATIVE AGENCY IN ITALY

PIEDMONT-LIGURIA
CO.RA.EL. SCRL
s.romano@corael.org

LOMBARDY
AGENTI ASSOCIATI
info@agentiassociati.eu

TRIVENETO
AGENZIA STUDIO LICHT S.N.C.
DI BELLORIO A. LARCHER M. & C.
bellorio68@gmail.com

EMILIA ROMAGNA
AGENZIA SOLARIS SNC
solaris@agenziasolaris.it

TUSCANY - UMBRIA
LIBRA SRL
luporini@tin.it

LAZIO
3EL SNC
info@3elrappresentanze.it

CAMPANIA
A.ELLE. SRL
info@aellesrl.com

MARCHE - ABRUZZO - MOLISE
FELIZIANI RAPPRESENTANZE SNC
info@feliziani.com

APULIA - BASILICATA
CARBONARA RAPPRESENTANZE
carbonara.nicola@tiscali.it

CALABRIA
FASCI' PASQUALE DOMENICO
rap.fasci@gmail.com

WESTERN SICILY
RES DI DANIELE LA MANTIA
res-pa@libero.it

EASTERN SICILY
UNILIGHT SNC
unilightsnc@gmail.com

SARDINIA
TECHNOENGINEERING SRL
tecnodistribuzione@gmail.com



Gi Gambarelli srl

Via per Reggio, 30/L-M
42019 Arceto (RE) - Italia
Vat/p.iva IT02128290356

+39 0522 980598
info@gigambarelli.com
gigambarelli.com

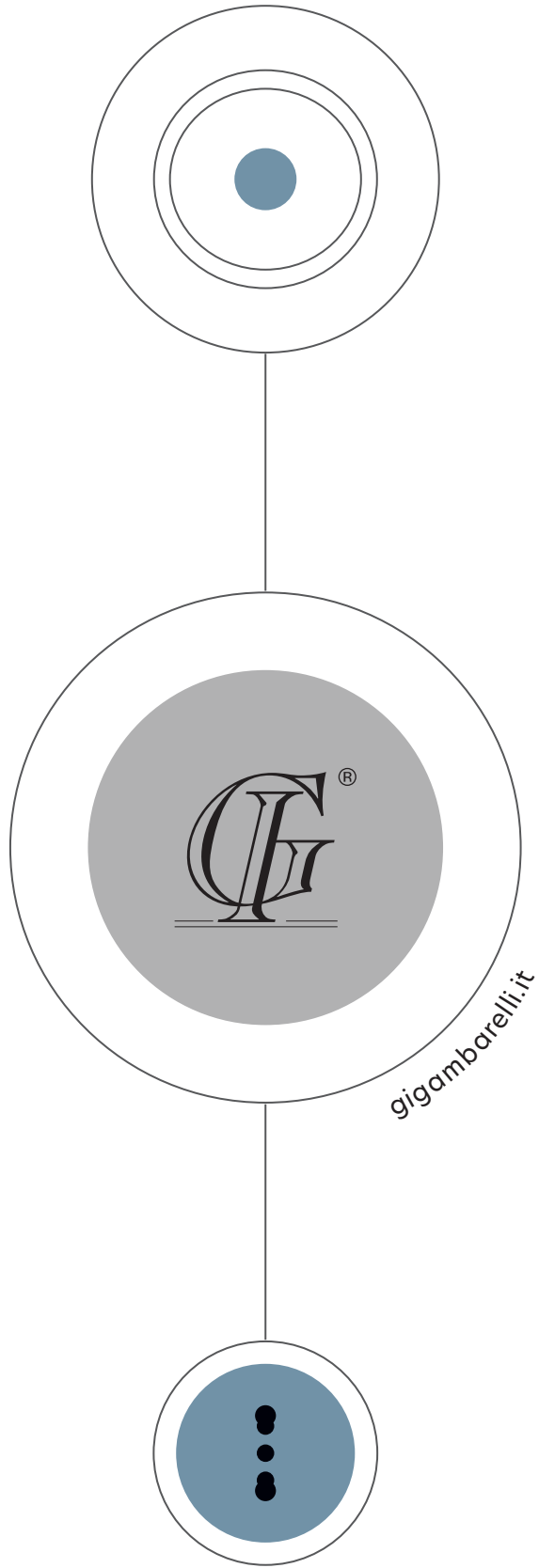

unforgettable

2023|2024 COLLECTIONS



gigambarelli.it

